

Advanced Filtration Co. of N.J., Inc.

P.O. Box 324 - Howell, N.J. 07731-0324

Phone: (732) 901-6676 FAX: (732) 901-6677

E-mail Address: sales@advancedfiltration.com



Pipeline Y-Strainers

Click here to send an inquiry to Advanced Filtration or phone (732) 901-6676
www.advancedfiltration.com

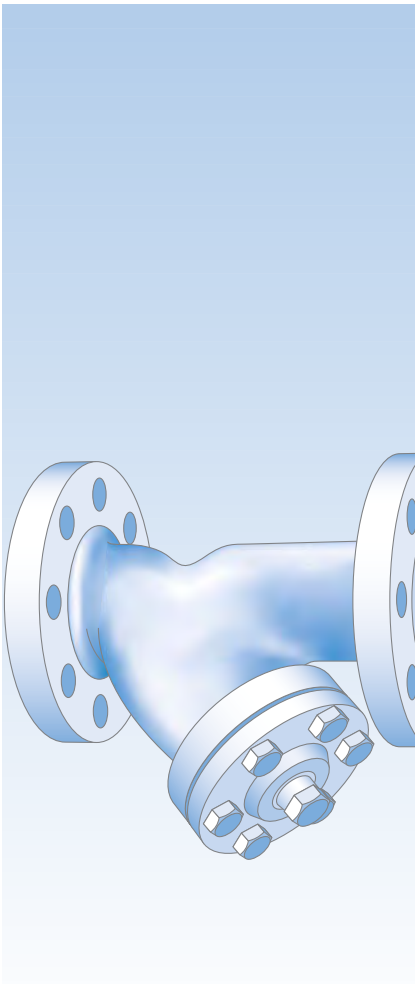

IFC Series Y-Strainers

IFC Series Y250 Cast Iron Threaded Y-Strainers	3
IFC Series Y125 and Y250 Cast Bronze Threaded and Sweat Y-Strainers	5
IFC Series Y300 Cast Steel Threaded and Socket Weld Y-Strainers	7
IFC Series Y600 and Y1500 Cast Steel Threaded and Socket Weld Y-Strainers ..	9
IFC Series Y600 and Y1500 Cast Steel Threaded and Socket Weld Y-Strainers with Bolted Covers	11
IFC Series Y125F, Y150F and Y250F Iron and Bronze Y-Strainers	13
IFC Series Y150F and Y300F Cast Steel Flanged Y-Strainers	15
IFC Series Y600F, Y900F and Y1500F Cast Steel Flanged Y-Strainers	17
Available Optional Features	19
Documented Testing	19

Engineering Data

Screen Openings for Y-Strainers	20
Y-Strainer Pressure Drop – Liquids	21
Screen Correction Factor Chart	22
Viscosity and Density Correction Factor Chart	22
Y-Strainer Pressure Drop – Saturated Steam (Sizes 1/4” to 1 1/2”)	23
Y-Strainer Pressure Drop – Saturated Steam (Sizes 2” to 16”)	24
Correction Factors For Clogged Screens	25
Y-Strainer Screen Burst Pressure	26
Y-Strainer Effective Screen Area	27

Check List and Suggested Specifications	28
Installation and Maintenance Instructions	29
How To Order	30

Notes: The material in this catalogue is for general information. For specific performance data and proper material selection, consult factory or your IFC representative. Although every attempt has been made to ensure that the information contained in this catalogue is correct IFC Inc. reserves the right to change designs, materials and/or specifications without notice.

Limited Warranty

All products are warranted to be free of defects in material and workmanship for a period of one year from the date of shipment, subject to the limitations below: If the purchaser believes a product defective, the purchaser shall: **(a)** Notify the manufacturer, state the alleged defect and request permission to return the product. **(b)** If permission is given, return the product with transportation prepaid. If the product is accepted for return and found to be defective, the manufacturer will, at its discretion, either repair or

replace the product, f.o.b. factory, within 60 days of receipt, or refund the purchase price.

Other than to repair, replace or refund described above, the purchaser agrees that the manufacturer shall not be liable for any losses, costs, expenses or damages of any kind arising out of the product, its use, installation or replacement, labeling, instructions, information or technical data of any kind, description of product use, sample or model, warnings or lack of foregoing. No other warranties,

written or oral, expressed or implied, including the warranties of fitness for a particular purpose and merchantability, are made or authorized.

No affirmation of fact, promise, description of product use or sample or model shall create any warranty from the manufacturer, unless signed by the president. These products are not manufactured, sold or intended for personal, family or household purposes.

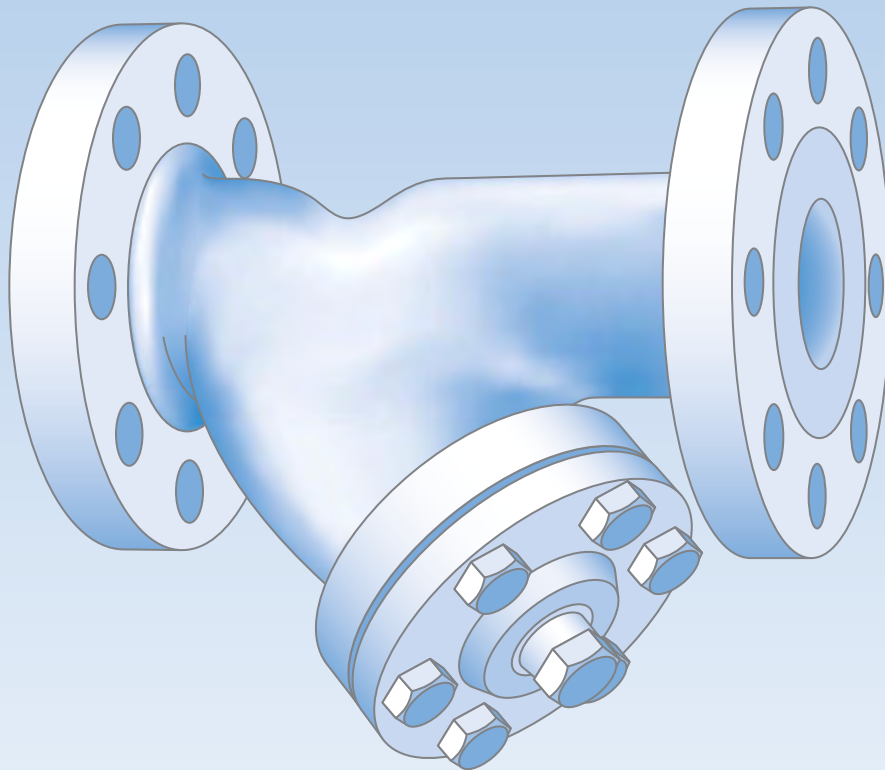

Features:

- Low pressure drop streamlined design.
- Generously sized strainer screens.
- Compact end to end dimension.

Available Materials of Construction:

- Cast Iron
- Ductile Iron
- Bronze
- Carbon Steel
- Low-Temp Steel
- Chrome Molly
- Stainless Steel

End Connections:

- Flat Faced (FF)
- Raised Face (RF)
- RTJ Flanged (RTJ)
- Butt-weld (BW)
- Threaded (NPT)
- Socket Weld (SW)
- Sweat (S)

Size Range:

- 1/4" (8mm) up to 16" (400mm)

Applications:

- Process Industry
- Power Industry
- Chemical Industry
- Oil and Gas
- Pulp and Paper
- Metals and Mining
- Water and Waste

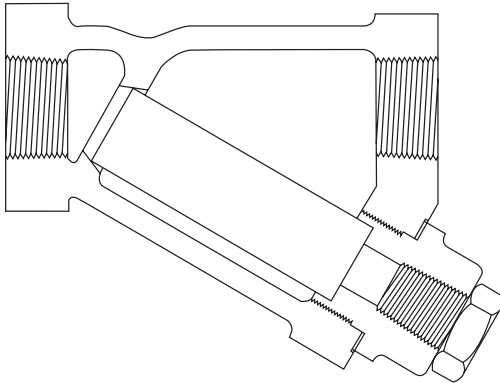

Design Features:

- Strainers are equipped with threaded (N.P.T.) inlet/outlet connections.
- Strainer body meets ASME B16.4.
- IFC series Y250TIT strainers equipped with threaded cover cap that utilize a flat gasket seal.
- IFC series Y250TIB strainers equipped with bolted cover flange that utilize a flat gasket seal.
- Upper and lower machined seats.
- 304 SS mesh screens are standard. Perforated plate screens are optional.
- Drain/Blow-off connection furnished with plug as standard.
- Generous screen area and properly proportioned straining chamber to minimize initial pressure drop while maximizing time between cleanings.

Parts List and Standard Materials		
Part	Model Y250TIT	Model Y250TIB
Body	A126-B	A126-B
Cap/Cover	A126-B	A126-B
Screen ¹	304SS	304SS
Plug ²	A126-B	A126-B
Gasket ¹	Non-asbestos	Non-asbestos

Upper Pressure Limits (Non-Shock)		
IFC Model	Body Material	M.A.W.P. psig (Bars)
Y250TIT, Y250TIB	A126-B	400 (27.58)

Lower Temperature Limits	
Body Material	Lower Limit ;F (;C)
A126-B	-20 (-28.9)

Notes: 1. Recommended Spares.
2. Materials of equivalent strength may be substituted at manufacturer's option.

Pressure Temperature Chart (In accordance with ASME B16.4)

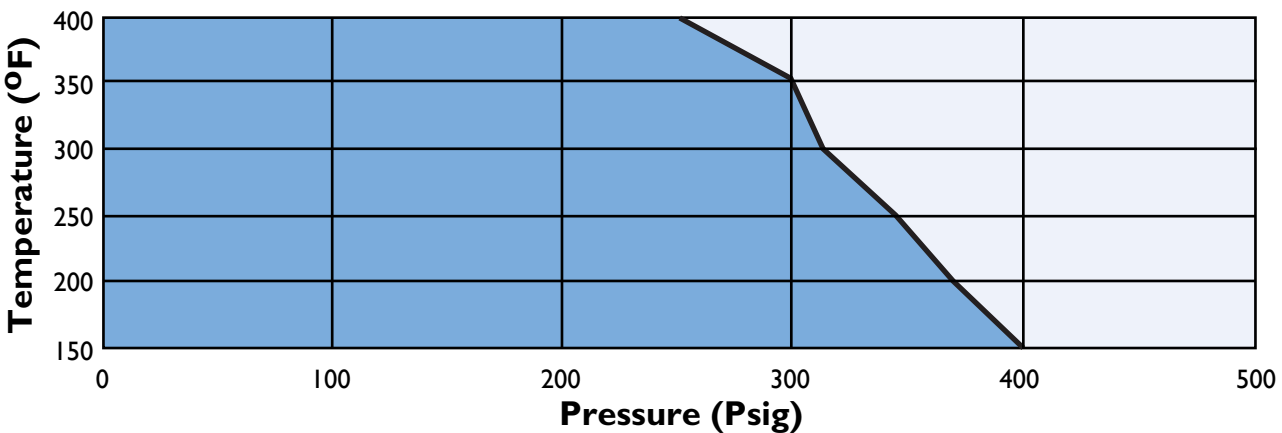

Note: Strainers may not be used on service where the temperature exceeds 406°F.

Standard Screens	
Size range	Opening
1/4" - 2"	0.032 in.
8mm - 50mm	0.8 mm
2 1/2" - 3"	0.045 in.
65mm - 80mm	1.2 mm

Notes:

IFC Model Y250TIT is shown.

Model Y250TIB is complete with a bolted cover.

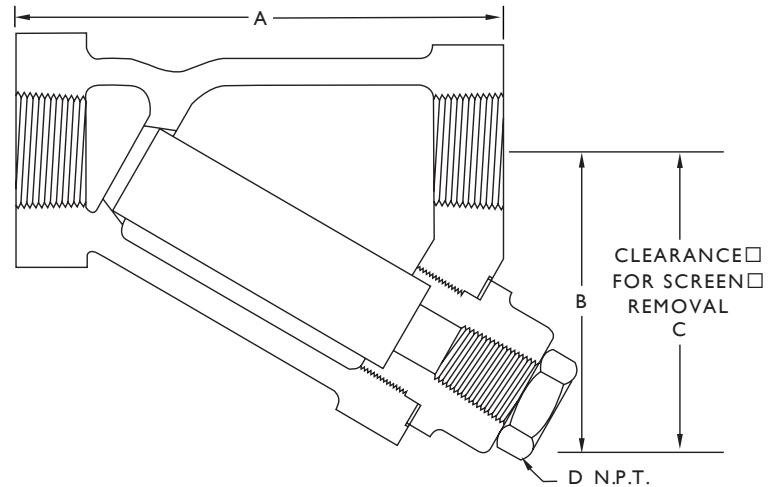

Dimensional Data (Class 250)

Size in (mm)	A in (mm)		B in (mm)		C in (mm)		D NPT in (mm)		Weight Lb. (Kg.)	
	Y250TIT	Y250TIB	Y250TIT	Y250TIB	Y250TIT	Y250TIB	Y250TIT	Y250TIB	Y250TIT	Y250TIB
1/4" 8	3.19 81	-	2.06 52	-	3.13 80	-	1/4 8	-	1.5 0.7	-
3/8" 10	3.19 81	-	2.06 52	-	3.13 80	-	1/4 8	-	1.5 0.7	-
1/2" 15	3.19 81	-	2.06 52	-	3.13 80	-	1/4 8	-	1.5 0.7	-
3/4" 20	3.75 95	-	2.44 62	-	3.69 94	-	3/8 10	-	2.5 1.1	-
1" 25	4.00 102	-	2.44 62	-	3.69 94	-	3/8 10	-	3 1.4	-
1 1/4" 32	5.00 127	-	3.38 86	-	5.06 129	-	3/4 20	-	5.5 2.5	-
1 1/2" 40	5.75 146	-	3.88 99	-	5.75 146	-	3/4 20	-	8 3.6	-
2" 50	7.00 178	-	4.75 121	-	7.25 184	-	1 25	-	13 5.9	-
2 1/2" 65	9.25 235	9.25 235	5.88 149	7.00 188	8.75 222	10.50 267	1 1/2 40	1 25	22 10	29 13
3" 80	10.00 254	10.00 254	6.00 1.63	8.00 203	9.00 2.29	11.50 292	1 1/2 40	1 25	30 14	39 18

General:

1. For further optional features see page 19.
2. Other perforations and screen materials available. Please see page 20.
3. For pressure loss information see page 21 and 23.
4. For ordering information please see page 30.
5. Dimensions shown are subject to change. Contact factory for certified prints when required.

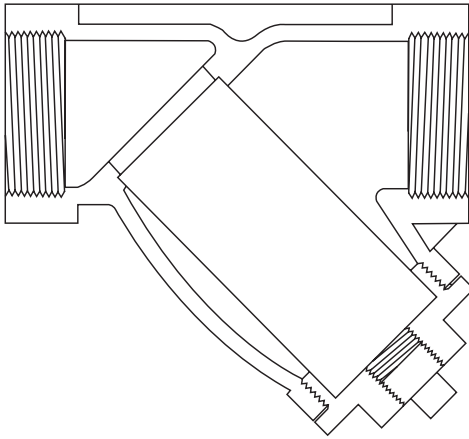

Design Features:

- Strainers are available with threaded (N.P.T.) or sweat (Class 125 Lb. Only) inlet/outlet connections.
- Strainer body meets ASME B16.15.
- Strainers equipped with threaded cover cap that utilize a flat gasket seal.
- Upper and lower machined seats.
- 304 SS mesh screens are standard. Perforated plate screens are optional.
- Drain/Blow-off connection furnished with plug as standard.
- Generous screen area and properly proportioned straining chamber to minimize initial pressure drop while maximizing time between cleanings.

Parts List and Standard Materials		
Part	Series Y125	Series Y250
Body	B62	B62
Cap	B62	B62
Screen ¹	304SS	304SS
Plug	B62	B62
Gasket ¹	Teflon	Silicon

Notes: 1. Recommended Spares.

Upper Pressure Limits (Non-Shock)		
IFC Model	Body Material	M.A.W.P. psig (Bars)
Y125TBT, Y125SBT	B62	200 (13.79)
Y250TBT	B62	400 (27.58)

Lower Temperature Limits	
Body Material	Lower Limit ;F (;C)
B62	-20 (-28.9)

Pressure Temperature Chart (in accordance with ASME B16.15)

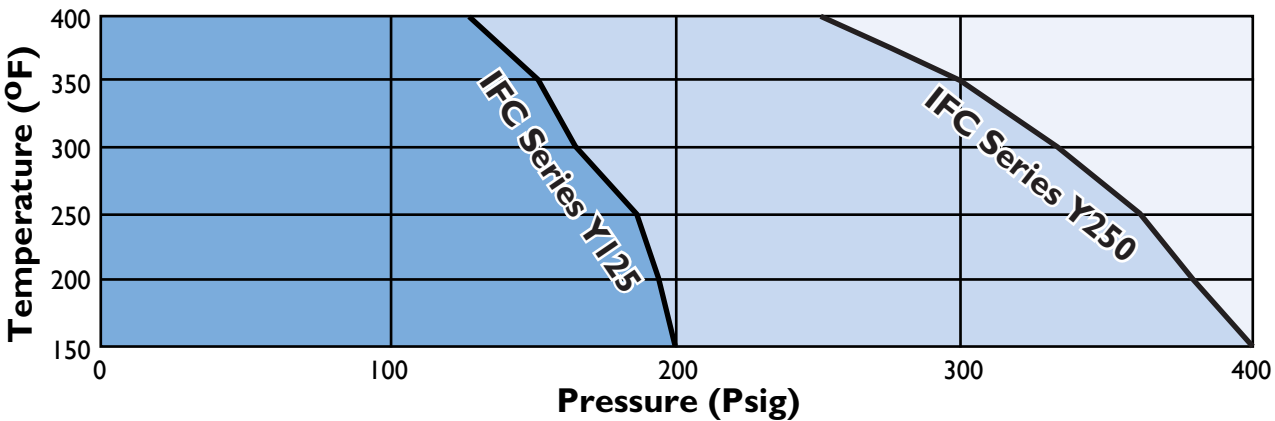

Note: Limited to 400°F maximum sustained operating temperature.

Standard Screens

Size range	Opening
3/8" - 2"	0.032 in.
10mm - 50mm	0.8 mm
2 1/2" - 3"	0.045 in.
65mm - 80mm	1.2 mm

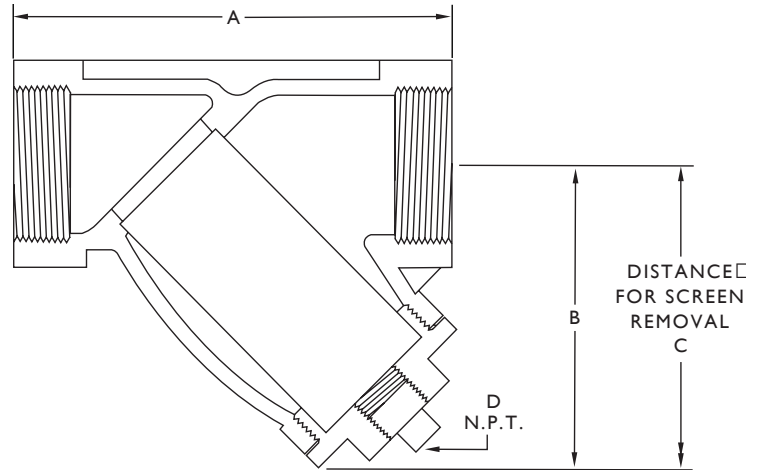

Dimensional Data (Classes 125, 250)

Size in (mm)	A in (mm)			B in (mm)		C in (mm)		D NPT in (mm)		Weight Lb. (Kg.)	
	Y125T	Y125S	Y250	Y125	Y250	Y125	Y250	Y125	Y250	Y125	Y250
3/8" 10	3.25 82	3.38 86	-	2.13 55	-	3.50 89	-	3/8 10	-	1.00 0.45	-
1/2" 15	3.25 82	3.38 86	3.06 78	2.13 55	2.25 57	3.50 89	3.88 99	3/8 10	3/8 10	1.00 0.45	1.25 0.57
3/4" 20	4.00 100	4.00 100	3.54 90	2.75 70	2.50 64	4.50 114	4.19 106	3/8 10	3/8 10	1.00 0.45	1.50 0.68
1" 25	4.50 115	5.00 127	4.19 106	3.00 75	3.19 81	5.00 127	4.88 124	1/2 15	3/4 20	2.00 0.91	2.00 0.91
1 1/4" 32	5.38 136	5.88 149	5.06 129	3.50 90	3.63 92	5.75 146	5.75 146	1/2 15	3/4 20	2.00 0.91	3.00 1.36
1 1/2" 40	6.25 158	6.88 175	5.94 151	3.88 98	4.19 106	6.38 162	6.63 168	1/2 15	3/4 20	3.00 1.36	4.00 1.81
2" 50	7.50 191	8.50 216	7.75 197	5.50 138	5.75 146	9.06 230	8.19 208	1/2 15	3/4 20	7.00 3.18	7.50 3.40
2 1/2" 65	9.06 230	9.06 230	-	6.00 150	-	10.00 254	-	1/2 15	-	9.75 4.42	-
3" 80	10.25 260	10.25 260	-	6.25 160	-	10.38 264	-	1/2 15	-	13.00 5.90	-

General:

1. For further optional features see page 19.
2. Other perforations and screen materials available. Please see page 20.
3. For pressure loss information see page 21 and 23.
4. For ordering information please see page 30.
5. Dimensions shown are subject to change. Contact factory for certified prints when required.

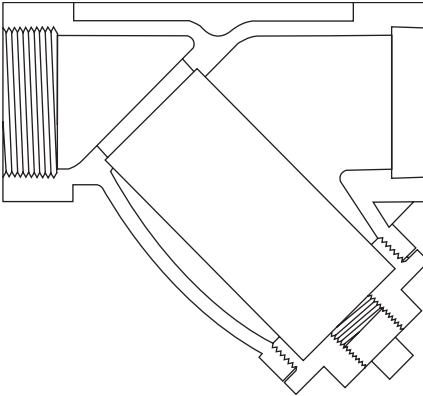

Design Features:

- Strainers are available with threaded (N.P.T.) or socket weld inlet/outlet connections.
- Strainer body meets applicable ASME Standard.
- One piece precision investment cast body.
- Strainers equipped with threaded cover cap that utilize a flat gasket seal.
- Upper and lower machined seats.
- 304 SS perforated screens are standard.
- Drain/Blow-off connection furnished with plug as standard.
- Generous screen area and properly proportioned straining chamber to minimize initial pressure drop while maximizing time between cleanings.

Parts List and Standard Materials

Part	Carbon Steel	Stainless Steel
Body	A216-WCB	A351-CF8M
Cap	A216-WCB	A351-CF8M
Screen ¹	304SS	304SS
Plug ²	A105	A182-316
Gasket ¹	Teflon	Teflon

Notes: 1. Recommended Spares.

2. Materials of equivalent strength may be substituted at manufacturer's option.

Upper Pressure Limits (Non-Shock)

IFC Model (Threaded)	Body Material	M.A.W.P. psig (Bars)
Y150TST	WCB	285 (19.65)
Y150TSST	CF8M	275 (18.96)
Y300TST	WCB	740 (51.02)
Y300TSST	CF8M	720 (49.64)

Lower Temperature Limits

Body Material	Lower Limit ;F (;C)
WCB	-20 (-28.9)
CF8M	-20 (-28.9)

Pressure Temperature Chart (in accordance with ASME B16.34, WCB)

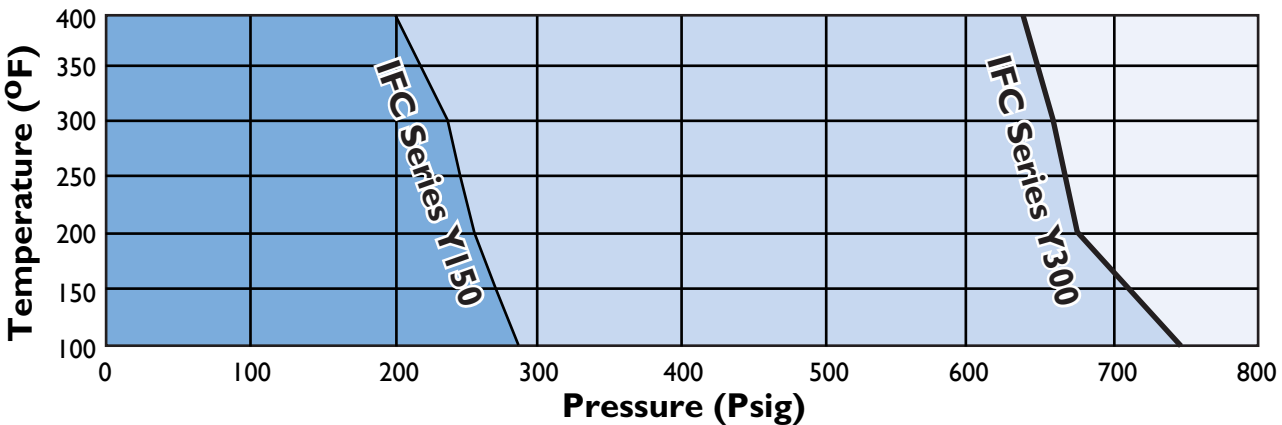

Note: Teflon limited to 400°F maximum sustained operating temperature.

When operating IFC series Y150 and Y300 cast steel strainers at higher temperatures please consult factory.

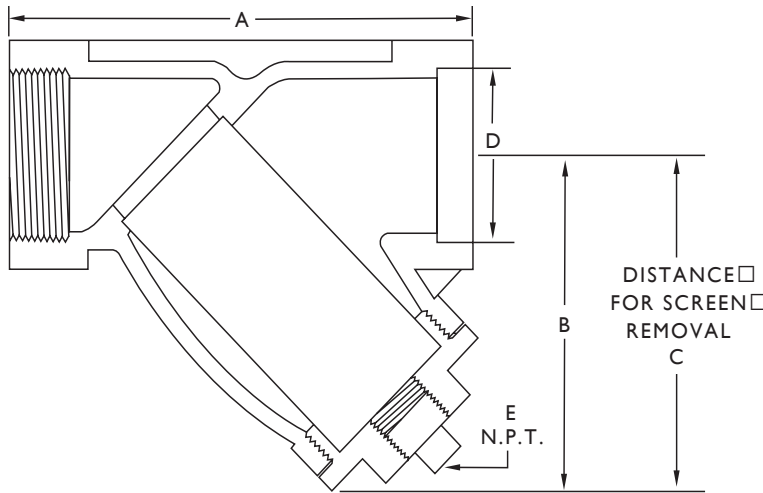

Standard Screens	
Size range	Opening
1/2" - 2"	0.032 in.
10mm - 50mm	0.8 mm
2 1/2" - 3"	0.045 in.
65mm - 80mm	1.2 mm

Dimensional Data (Class 150, 300)

Size in (mm)	A in (mm)		B in (mm)		C in (mm)		D in (mm)		E NPT in (mm)		Weight Lb. (Kg.)	
	Y150	Y300	Y150	Y300	Y150	Y300	Y150	Y300	Y150	Y300	Y150	Y300
1/2" 15	-	2.31 59	-	1.56 40	-	2.38 60	-	0.855 21.72	-	3/8 10	-	0.50 0.22
3/4" 20	-	3.13 80	-	2.13 54	-	3.19 81	-	1.065 27.05	-	3/8 10	-	0.82 0.37
1" 25	-	3.31 84	-	2.63 67	-	4.00 102	-	1.330 33.78	-	1/2 15	-	1.50 0.68
1 1/4" 32	-	4.13 105	-	3.00 76	-	4.50 114	-	1.675 42.55	-	1/2 15	-	2.0 0.90
1 1/2" 40	-	4.69 119	-	3.19 81	-	4.75 121	-	1.915 48.64	-	1/2 15	-	2.75 1.25
2" 50	-	5.44 138	-	3.81 97	-	5.75 146	-	2.406 61.11	-	1/2 15	-	4.25 1.90
2 1/2" 65	7.19 183	7.19 183	4.88 124	4.88 124	7.25 184	7.25 184	2.906 73.81	2.906 73.81	1/2 15	1/2 15	10 4.54	10 4.54
3" 80	8.00 203	8.00 203	5.25 133	5.25 133	7.50 190	7.50 190	3.535 89.79	3.535 89.79	1/2 15	1/2 15	14 6.35	14 6.35

General:

1. For further optional features see page 19.
2. Other perforations and screen materials available. Please see page 20.
3. For pressure loss information see page 21 and 23.
4. For ordering information please see page 30.
5. Dimensions shown are subject to change. Contact factory for certified prints when required.

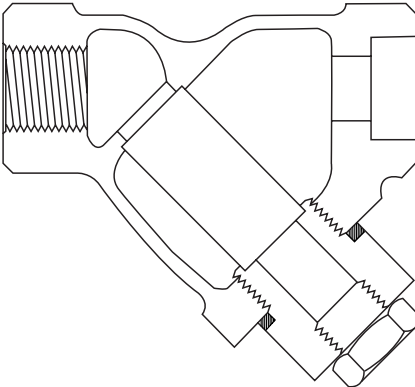

Design Features:

- Strainers are available with threaded (N.P.T.) or socket weld inlet/outlet connections.
- Strainer body meets ASME B1 6.34.
- Threaded and socket weld end connections meet the requirements of table 4 of ASME B1 6.34.
- Strainers equipped with threaded cover cap that utilize a flat gasket seal.
- Upper and lower machined seats.
- 304 SS perforated screens are standard. Alloy 20 strainers complete with Alloy 20 as standard.
- Drain/Blow-off connection furnished with plug as standard.
- Generous screen area and properly proportioned straining chamber to minimize initial pressure drop while maximizing time between cleanings.

Parts List and Standard Materials

Part	Carbon Steel	Chrome Molly	Stainless Steel	Carbon Steel Low Temp. (-50F)	Alloy 20
Body	A216-WCB	A217-WC6	A351-CF8M	A352-LCB	A351-CN7M
Cap ²	A216-WCB	A217-WC6	A351-CF8M	A351-CF8M	A351-CN7M
Screen ¹	304 SS	304 SS	304 SS	304 SS	Alloy 20
Plug ²	A105	A182-F11	A182-316	A182-316	B462
Gasket ¹	304 SS Spiral Wound	304 SS Spiral Wound	304 SS Spiral Wound	304 SS Spiral Wound	Alloy 20 Spiral Wound

Upper Pressure Limits (Non-Shock)

IFC Model (Threaded)	Body Material	M.A.W.P. psig (Bars)
Y600TST	WCB	1480 (102.04)
Y600TSST	CF8M	1440 (99.28)
Y600TA20T	CN7M	1200 (82.74)
Y600TLCBT	LCB	1390 (95.84)
Y1500TST	WCB	3705 (255.45)
Y1500T52CMT	WC6	3750 (258.55)
Y1500TSST	CF8M	3600 (248.21)

Lower Temperature Limits

Body Material	Lower Limit ;F (;C)
WCB, WC6	-20 (-28.9)
CF8M, CN7M	-20 (-28.9)
LCB	-50 (-45.6)

- Notes:** 1. Recommended Spares.
2. Materials of equivalent strength may be substituted at manufacturer's option.

Pressure Temperature Chart (in accordance with ASME B16.34, WCB)

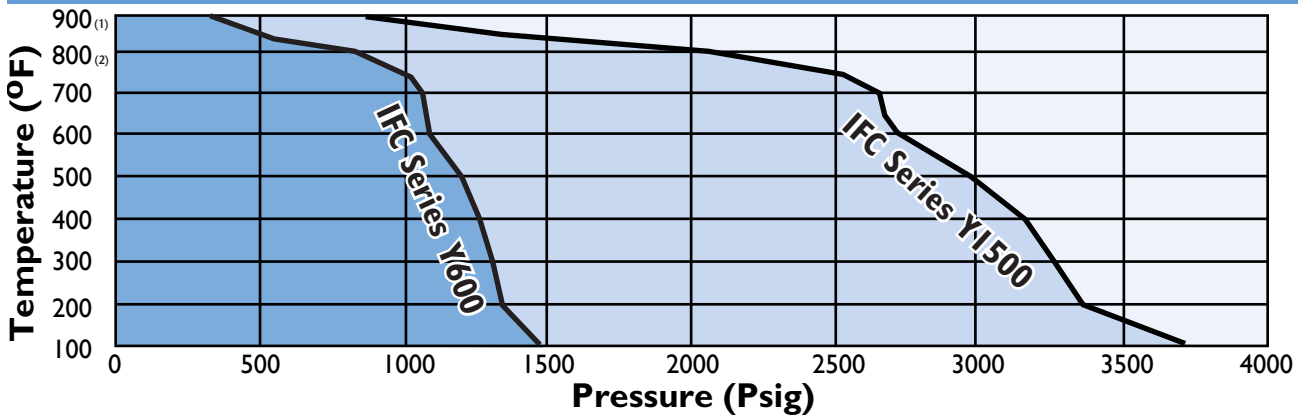

- Notes:** 1. Graphite filled 304 SS Spiral Wound gaskets limited to 900°F in an oxidizing atmosphere. When operating strainers at higher temperatures please consult factory.
2. Upon prolonged exposure to temperatures above 800°F, the carbide phase of carbon steel may be converted to graphite.

Standard Screens	
Size range	Opening
1/2" - 1 1/2"	0.032 in.
15mm - 40mm	0.8 mm
2"	0.032 in.
50mm	0.8 mm

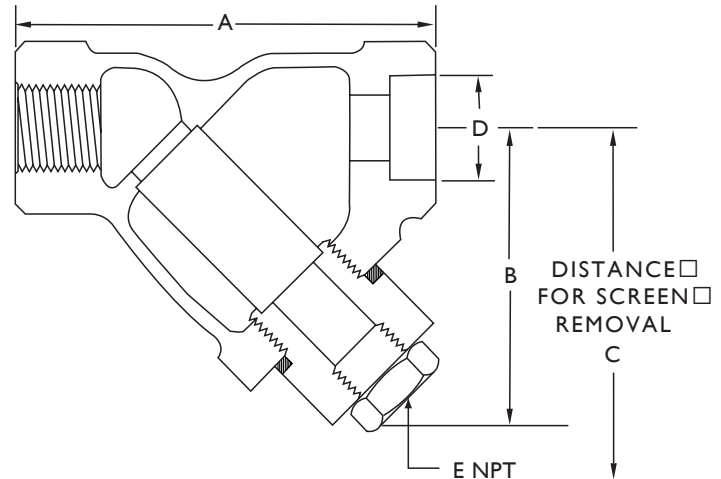

Dimensional Data (Classes 600, 1500)

Size in (mm)	A in (mm)		B in (mm)		C in (mm)		D in (mm)	E NPT in (mm)		Weight Lb. (Kg.)	
	Y600	Y1500	Y600	Y1500	Y600	Y1500		Y600	Y1500	Y600	Y1500
1/2" 15	3.00 76	3.94 100	2.44 62	3.81 97	3.13 80	5.31 135	0.855 21.72	1/4 8	1/4 8	2 0.9	2.5 1.1
3/4" 20	3.75 95	4.25 108	2.94 75	4.19 106	3.56 90	5.00 127	1.065 27.05	3/8 10	3/8 10	3 1.4	4 1.8
1" 25	4.63 118	5.00 127	3.75 95	5.38 137	3.94 100	7.50 178	1.330 33.78	3/8 10	1/2 15	5 2.3	7 3.2
1 1/4" 32	5.00 127	-	4.00 102	-	4.25 108	-	1.675 42.55	3/4 20	-	7 3.2	-
1 1/2" 40	5.63 143	-	4.81 122	-	6.56 167	-	1.915 48.64	3/4 20	-	10 4.5	-
2" 50	7.00 178	-	6.13 156	-	6.75 171	-	2.406 61.11	1 25	-	15 6.8	-

Note: Drain/Blow-off connections are optional. Please contact factory.

General:

1. For further optional features see page 19.
2. Other perforations and screen materials available. Please see page 20.
3. For pressure loss information see page 21 and 23.
4. For ordering information please see page 30.
5. Dimensions shown are subject to change. Contact factory for certified prints when required.

IFC Series Y600 and YI500 Cast Steel Threaded and Socket Weld Y-Strainers with Bolted Covers

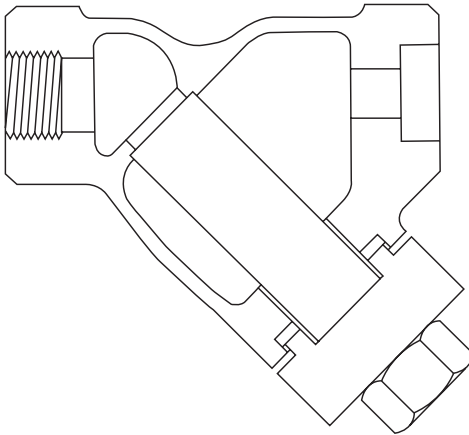

Design Features:

- Strainers are available with threaded (N.P.T.) or socket weld inlet/outlet connections.
- Strainer body meets ASME B16.34.
- Threaded and socket weld end connections meet the requirements of table 4 of ASME B16.34.
- Strainers equipped with bolted cover flange that utilize a flat gasket seal.
- Bolted cover designed to meet the requirements of ASME Section VIII, Div. I, Appendix 2 and/or ASME B16.5.
- Upper and lower machined seats.
- 304 SS perforated screens are standard.
- Drain/Blow-off connections are optional. Please consult factory.
- Generous screen area and properly proportioned straining chamber to minimize initial pressure drop while maximizing time between cleanings.

Parts List and Standard Materials

Part	Carbon Steel	Chrome Molly	Stainless Steel
Body	A216-WCB	A217-WC6	A351-CF8M
Cover ²	A216-WCB	A217-WC6	A351-CF8M
Screen ¹	304 SS	304 SS	304 SS
Gasket ¹	304 SS Spiral Wound	304 SS Spiral Wound	304 SS Spiral Wound
Stud	A193-B7	A193-B7	A193-B8-1
Nut	A194-2H	A194-2H	A194-8

Notes: 1. Recommended Spares.

2. Materials of equivalent strength may be substituted at manufacturer's option.

Upper Pressure Limits (Non-Shock)

IFC Model (Threaded)	Body Material	M.A.W.P. psig (Bars)
Y600TSB	WCB	1480 (102.04)
Y600TSSB	CF8M	1440 (99.28)
YI500TSB	WCB	3705 (255.45)
YI500T52CMB	WC6	3750 (258.55)
YI500TSSB	CF8M	3600 (248.21)

Lower Temperature Limits

Body Material	Lower Limit ;F (°C)
WCB, WC6, CF8M	-20 (-28.9)

Pressure Temperature Chart (in accordance with ASME B16.34, WCB)

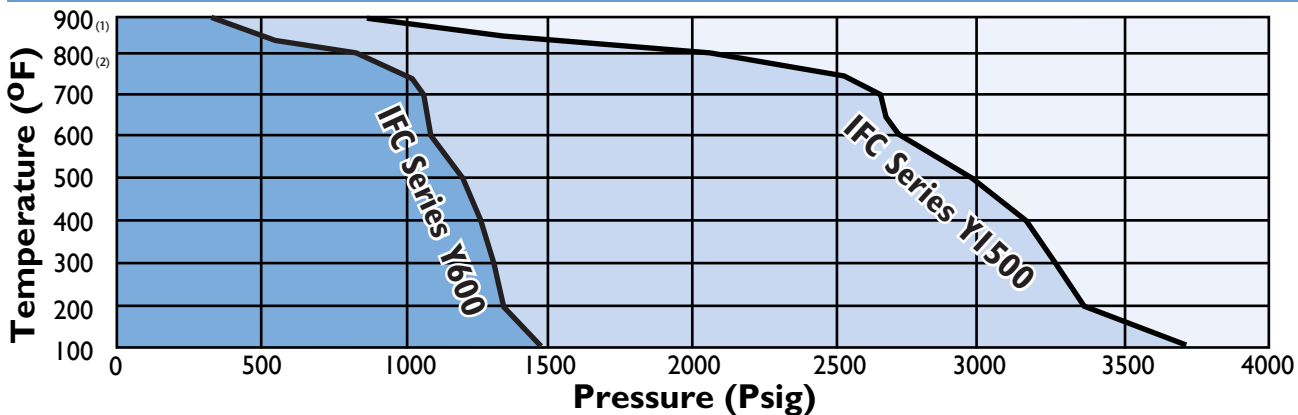

Notes: 1. Graphite filled 304 SS Spiral Wound gaskets limited to 900°F in an oxidizing atmosphere.

When operating strainers at higher temperatures please consult factory.

2. Upon prolonged exposure to temperatures above 800°F, the carbide phase of carbon steel may be converted to graphite.

Standard Screens	
Size range	Opening
1/2" - 1 1/2"	0.032 in.
15mm - 40mm	0.8 mm
2" - 3"	0.045 in.
50mm - 80mm	1.2 mm

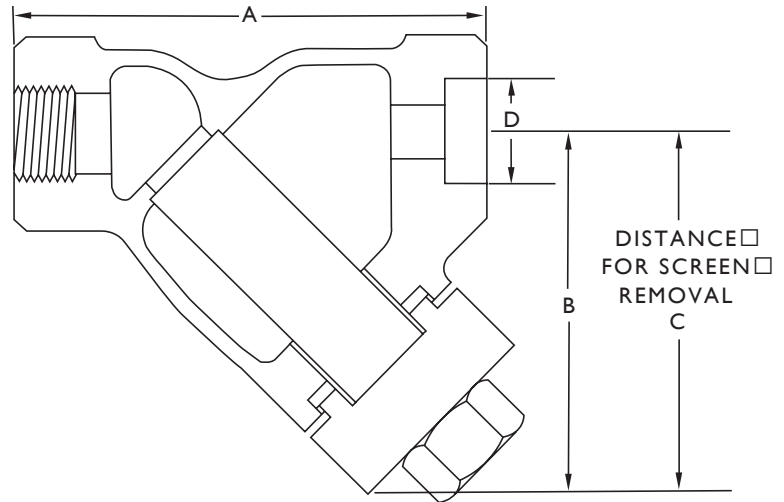

Dimensional Data (Classes 600, 1500)										
Size in (mm)	A in (mm)		B in (mm)		C in (mm)		D in (mm)		Weight Lb. (Kg.)	
	Y600	Y1500	Y600	Y1500	Y600	Y1500	Y600	Y1500	Y600	Y1500
1/2"	-	3.94	-	3.00	-	4.25	-	0.855	-	7
15	-	100	-	76	-	108	-	21.72	-	3.2
3/4"	-	4.25	-	3.50	-	5.00	-	1.065	-	10
20	-	108	-	89	-	127	-	27.05	-	4.5
1"	-	5.00	-	4.50	-	5.63	-	1.330	-	16
25	-	127	-	114	-	143	-	33.78	-	7.3
1 1/4"	-	8.38	-	6.19	-	8.63	-	1.675	-	22
32	-	213	-	157	-	219	-	42.55	-	10
1 1/2"	-	8.38	-	6.19	-	8.63	-	1.915	-	22
40	-	213	-	157	-	219	-	48.64	-	10
2"	-	9.38	-	7.19	-	10.00	-	2.406	-	30
50	-	238	-	183	-	254	-	61.11	-	13.6
2 1/2"	14.50	-	9.13	-	10.38	-	2.906	-	63	-
65	394	-	232	-	264	-	74	-	29	-
3"	15.63	-	10.13	-	11.38	-	3.535	-	77	-
80	397	-	257	-	289	-	90	-	35	-

- Notes:**
- IFC Series Y600 strainers are supplied with a 1" FN.P.T. drain.
 - Drain/Blow-off connections are optional on IFC Series Y1500 strainers.
 - Strainers constructed from A216-WC6 are available in IFC Series Y1500 sizes 1 1/4", 1 1/2" and 2" only.

General:

- For further optional features see page 19.
- Other perforations and screen materials available. Please see page 20.
- For pressure loss information see page 21 and 23.
- For ordering information please see page 30.
- Dimensions shown are subject to change. Contact factory for certified prints when required.

IFC Series Y125F, Y150F and Y250F Iron and Bronze Flanged Y-Strainers

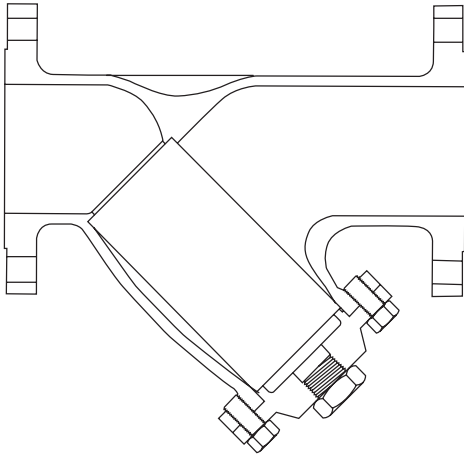

Design Features:

- Iron strainers are complete with FF (Series Y125F) or RF (Series Y250F) flanges in accordance with ASME B16.1.
- Bronze strainers are complete with FF flanges in accordance with ASME B16.24.
- Strainer body meets applicable ASME Standard.
- One piece cast body.
- Strainers equipped with bolted cover flange that utilize a flat gasket seal.
- Upper and lower machined seats.
- 304 SS perforated screens are standard.
- Drain/Blow-off connection furnished with plug as standard.
- Generous screen area and properly proportioned straining chamber to minimize initial pressure drop while maximizing time between cleanings.

Parts List and Standard Materials

Part IFC Model	Cast Iron Y125FIB	Ductile Iron Y250FDIB	Bronze Y150FBB
Body	A126-B	A395	B62
Cover	A126-B	A395	B62
Screen ¹	304 SS	304 SS	304 SS
Plug ²	A126-B	A126-B	B62
Gasket ¹	Graphite	Graphite	Non-asbestos
Bolt/Stud ²	A307-B	A307-B	Nonferrous
Nut ²	A563	A563	-

Notes: 1. Recommended Spares.

2. Materials of equivalent strength may be substituted at manufacturer's option.

Upper Pressure Limits (Non-Shock)

IFC Model	Body Material	M.A.W.P. psig (Bars)
Y125FIB (Up to 12" size)	A126-B	200 (13.79)
Y125FIB (Sizes 14" and up)	A126-B	150 (10.34)
Y150FBB	B62	225 (15.51)
Y250FDIB	A395	500 (34.47)

Lower Temperature Limits

Body Material	Lower Limit $^{\circ}$ F ($^{\circ}$ C)
A126-B, A395, B62	-20 (-28.9)

Pressure Temperature Chart (in accordance with ASME B16.1 and ASME B16.34)

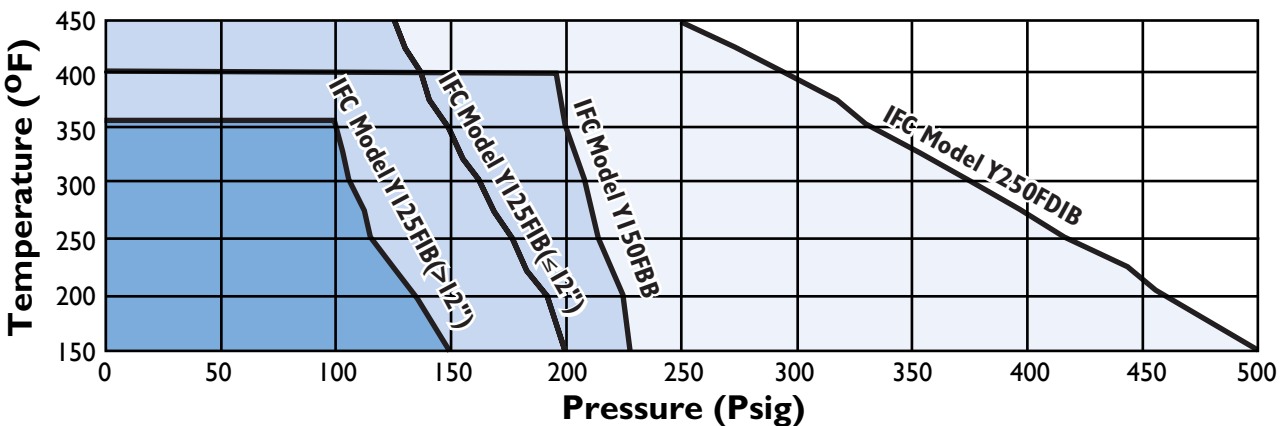

Note: Max rating temperature for IFC Model Y150FBB limited by codes such as ASME B31.1, ASME B31.5, etc.

Standard Screens

Size range	Opening
2" - 3"	0.045 in.
50mm - 80mm	1.2 mm
4" & larger	0.125 in.
100mm & larger	3.2 mm

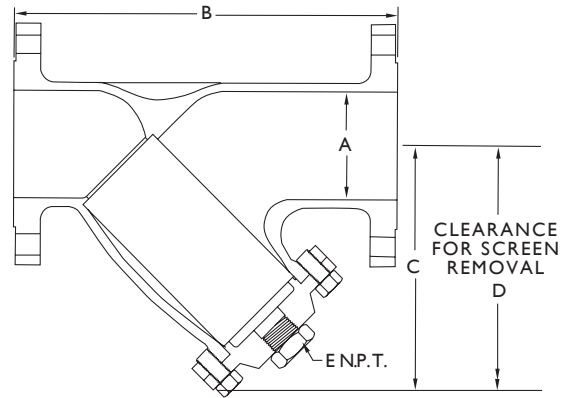

Dimensional Data (Bronze Class 150)

Size in (mm)	A in (mm)	B in (mm)	C in (mm)	D in (mm)	E NPT in (mm)	Weight Lb. (Kg.)
2"	2.00	8.63	5.25	7.5	1/2	20
50	51	219	133	191	15	9
2 1/2"	2.50	10.25	7.00	9.88	3/4	32
65	64	260	178	251	20	15
3"	3.00	11.63	7.69	10.88	3/4	36
80	76	295	195	276	20	16
4"	4.00	14.38	9.13	13.00	1 1/2	61
100	102	365	232	330	40	28
6"	6.00	18.63	13.00	18.38	2	160
150	152	473	330	467	50	73
8"	8.00	24.38	15.31	21.63	2	210
200	203	619	389	549	50	95

Dimensional Data (Iron Classes 125, 250) *use columns from chart above

	YI25	Y250	YI25	Y250	YI25	Y250	YI25	Y250	YI25	Y250	YI25	Y250
2"	2.00	2.00	8.88	8.88	6.00	6.50	8.50	9.13	1/2	1/2	22	28
50	51	51	226	226	152	165	216	232	15	15	10	13
2 1/2"	2.50	2.50	10.75	11.25	8.00	7.00	11.25	9.88	1	1	35	38
65	64	64	273	289	203	178	286	251	25	25	16	17
3"	3.00	3.00	11.50	11.63	8.75	8.00	12.25	11.25	1	1	43	54
80	76	76	292	295	222	203	311	286	25	25	20	24
4"	4.00	4.00	13.88	14.50	9.50	10.75	13.38	15.00	1 1/4	1	75	110
100	102	102	353	368	241	273	340	381	32	25	34	50
5"	5.00	5.00	16.38	17.38	11.50	13.50	16.13	19.00	1 1/4	1 1/4	115	160
125	127	127	416	441	292	343	410	483	32	32	52	73
6"	6.00	6.00	18.50	18.75	12.63	16.25	17.69	22.75	1 1/2	1 1/2	154	224
150	152	152	470	476	321	413	449	578	40	40	70	102
8"	8.00	8.00	21.38	21.88	16.38	19.50	23.00	27.75	1 1/2	1 1/2	243	468
200	203	203	543	556	416	495	584	692	40	40	110	212
10"	10.00	10.00	26.00	27.25	19.00	21.25	26.70	29.75	2	2	390	590
250	254	254	660	692	483	540	678	756	50	50	177	268
12"	12.00	12.00	30.00	31.38	22.00	25.00	31.00	35.00	2	2	650	890
300	305	305	762	797	559	635	787	889	50	50	295	404
14"	14.00	-	37.38	-	29.00	-	41.00	-	2	-	815	-
350	356	-	949	-	737	-	1041	-	50	-	370	-
16"	16.00	-	42.50	-	33.00	-	46.00	-	2	-	1224	-
400	406	-	1080	-	838	-	1168	-	50	-	555	-

General:

- For further optional features see page 19.
- Other perforations and screen materials available. Please see page 20.
- For pressure loss information see page 21 and 23.
- For ordering information please see page 30.
- Dimensions shown are subject to change. Contact factory for certified prints when required.

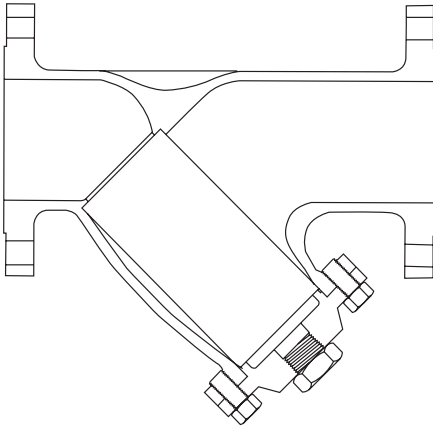

Design Features:

- Strainers available with RF flanged (ANSI B16.5) or butt-weld (ANSI B16.25) end connections.
- Strainer body meets ASME B16.5 and ASME B16.34.
- One piece cast body.
- Strainers equipped with bolted cover flange that utilize a flat gasket seal.
- Bolted cover designed to meet the requirements of ASME Section VIII, Div. I, Appendix 2 and/or ASME B16.5.
- Upper and lower machined seats.
- 304 SS perforated screens are standard.
- Drain/Blow-off connection furnished with plug as standard.
- Generous screen area and properly proportioned straining chamber to minimize initial pressure drop while maximizing time between cleanings.

Parts List and Standard Materials

Part	Carbon Steel	Stainless Steel
Body	A216-WCB	A351-CF8M
Cover	A216-WCB	A351-CF8M
Screen ¹	304SS	304SS
Plug	A105	A182-316
Gasket ^{1,2}	Series Y150: Teflon Series Y300: 304 SS Spiral Wound	Series Y150: Teflon Series Y300: 304 SS Spiral Wound
Stud	A193-B7	A193-B8-1
Nut	A194-2H	A194-8

Upper Pressure Limits (Non-Shock)

IFC Model (RF Flanged)	Body Material	M.A.W.P. psig (Bars)
Y150FSB	WCB	285 (19.65)
Y150FSSB	CF8M	275 (18.96)
Y300FSB	WCB	740 (51.02)
Y300FSSB	CF8M	720 (49.64)

Lower Temperature Limits

Body Material	Lower Limit °F (°C)
WCB	-20 (-28.9)
CF8M	-20 (-28.9)

Notes: 1. Recommended Spares.

2. Non-asbestos fabric gasket may be substituted at manufacturers option.

3. Also available in A352-LCC.

Pressure Temperature Chart (in accordance with ASME B16.5, WCB)

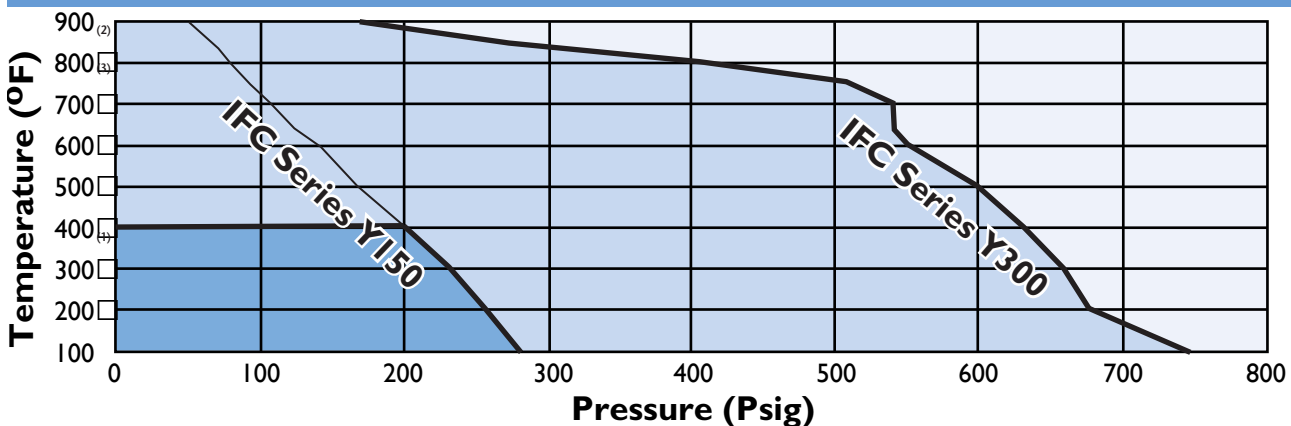

Notes: 1. Teflon and blueguard limited to 400°F maximum sustained operating temperature.

When operating IFC Series Y150 strainers at higher temperatures please consult factory.

2. Graphite filled 304 SS Spiral Wound gaskets limited to 900°F in an oxidizing atmosphere.

When operating IFC Series Y300 strainers at higher temperatures please consult factory.

3. Upon prolonged exposure to temperatures above 800°F, the carbide phase of carbon steel may be converted to graphite.

Standard Screens

Size range	Opening
1/2" - 1 1/2"	0.032 in.
15mm - 40mm	0.8mm
2" - 3"	0.045 in.
50mm - 80mm	1.2mm
4" & larger	0.125 in.
100mm & larger	3.2mm

Note: Flanged end strainer shown.
Butt-weld end strainer dimensionally the same.

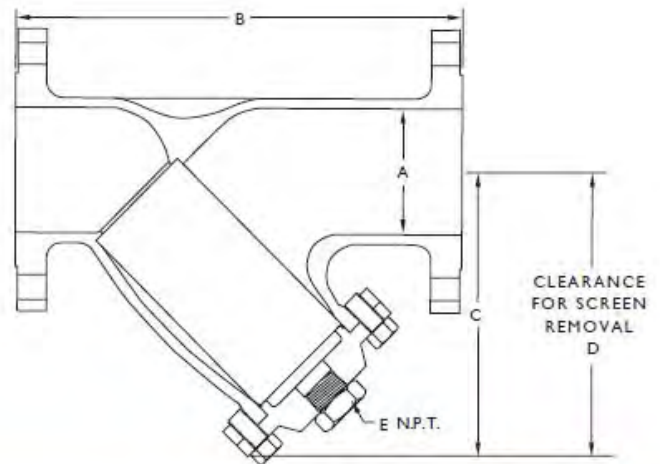

Dimensional Data (Classes 150, 300)

Size ¹ in (mm)	A in (mm)		B in (mm)		C in (mm)		D in (mm)		E NPT ² in (mm)		Weight Lb. (Kg.)	
	150	300	150	300	150	300	150	300	150	300	150	300
1/2"	0.5	0.5	6.00	6.50	3.88	4.25	4.75	5.75	1/4	1/4	5.5	8
15	13	13	152	165	99	108	121	146	8	8	2.5	3.6
3/4"	0.75	0.75	7.00	7.75	4.25	5.00	5.75	6.75	3/8	3/8	6.5	14
20	19	19	178	197	108	127	146	171	10	10	3	6.4
1"	1.00	1.00	7.50	7.88	4.75	5.50	6.38	8.12	1/2	1/2	9	15
25	25	25	191	200	121	140	162	206	15	15	4	6.8
1 1/2"	1.50	1.50	9.00	10.50	5.63	7.00	9.00	10.25	1/2	1/2	12	32
40	38	38	229	267	143	178	229	260	15	15	5.5	15
2"	2.0	2.0	8.63	9.32	5.25	5.69	7.50	8.00	1/2	1/2	20	26
50	51	51	219	236	133	145	191	203	15	15	9	12
2 1/2"	2.5	2.5	10.25	10.88	7.50	7.19	10.50	10.25	3/4	1	32	36
65	64	64	260	276	191	183	267	260	20	25	14.5	79
3"	3.00	3.00	11.63	12.63	7.69	8.13	10.88	11.50	1	1	36	55
80	76	76	295	320	195	207	276	292	25	25	16	25
4"	4.00	4.00	14.38	14.63	9.13	9.63	13.00	13.63	1 1/2	1 1/2	61	88
100	102	102	365	372	232	245	330	346	40	40	28	40
5"	5.00	5.00	17.63	18.50	11.00	15.38	17.00	21.50	2	2	110	180
125	127	127	448	470	279	391	432	546	50	50	50	82
6"	6.00	6.00	18.63	19.75	13.00	15.00	18.38	21.50	2	2	160	200
150	152	152	473	502	330	381	467	546	50	50	73	91
8"	8.00	8.00	24.38	25.00	15.32	16.50	21.63	22.00	2	2	210	290
200	203	203	619	635	389	419	549	559	50	50	95	132
10"	10.00	10.00	26.00	27.75	19.13	21.19	27.00	30.00	2	2	440	520
250	254	254	660	705	486	538	686	762	50	50	200	236
12"	12.00	12.00	30.38	33.00	22.00	24.31	31.00	34.38	2	2	585	680
300	305	305	772	838	559	617	787	873	50	50	265	308

Notes: 1. Other sizes available. Consult factory.
2. Other sizes and connection types available. Consult factory.

General:

- For further optional features see page 19.
- Other perforations and screen materials available. Please see page 20.
- For pressure loss information see page 21 and 23.
- For ordering information please see page 30.
- Dimensions shown are subject to change. Contact factory for certified prints when required.

IFC Series Y600F, Y900F and Y1500F Cast Steel Flanged Y-Strainers

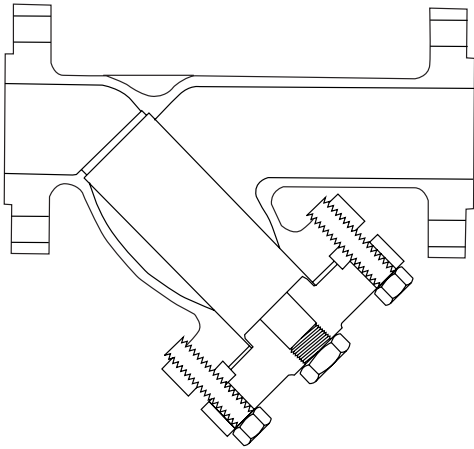

Design Features:

- Strainers available with RF or RTJ flanged (ANSI B16.5) or butt-weld (ANSI B16.25) end connections.
- Strainer body meets ASME B16.5 and ASME B16.34.
- One piece cast body.
- Body cover flanges are in dimensional accordance with ASME B16.5.
- Strainers equipped with a bolted cover flange.
- Bolted cover designed to meet the requirements of ASME Section VIII, Div.1, Appendix 2 and/or ASME B16.5.
- Upper and lower machined seats.
- 304 SS perforated screens are standard.
- Drain/Blow-off connection furnished with plug as standard (IFC Series Y600 Only).
- Generous screen area and properly proportioned straining chamber to minimize initial pressure drop while maximizing time between cleanings.

Parts List and Standard Materials

Part	Carbon Steel	Stainless Steel
Body	A216-WCB	A351-CF8M
Cover ²	A216-WCB	A351-CF8M
Screen ¹	304 SS	304 SS
Plug	A105	A182-316
Gasket ¹	304 SS Spiral Wound	304 SS Spiral Wound
Stud	A193-B7	A193-B8-1
Nut	A194-2H	A194-8

- Notes:** 1. Recommended Spares.
2. Materials of equivalent strength may be substituted at manufacturer's option.
3. Also available with ASTM A217-WC6 body and cover.

Upper Pressure Limits (Non-Shock)

IFC Model (Flanged)	Body Material	M.A.W.P. psig (Bars)
Y600FSB	WCB	1480 (102.04)
Y600F52CMB	WC6	1500 (103.42)
Y600FSSB	CF8M	1440 (99.28)
Y900FSB	WCB	2220 (153.06)
Y900F52CMB	WC6	2250 (155.12)
Y900FSSB	CF8M	2160 (148.93)
Y1500FSB	WCB	3705 (255.45)
Y1500F52CMB	WC6	3750 (258.55)
Y1500FSSB	CF8M	3600 (248.21)

Upper Pressure Limits (Non-Shock)

Body Material	Lower Limit ;F (;C)
WCB, WC6	-20 (-28.9)
CF8M	-20 (-28.9)

Pressure Temperature Chart (in accordance with ASME B16.5, WCB)

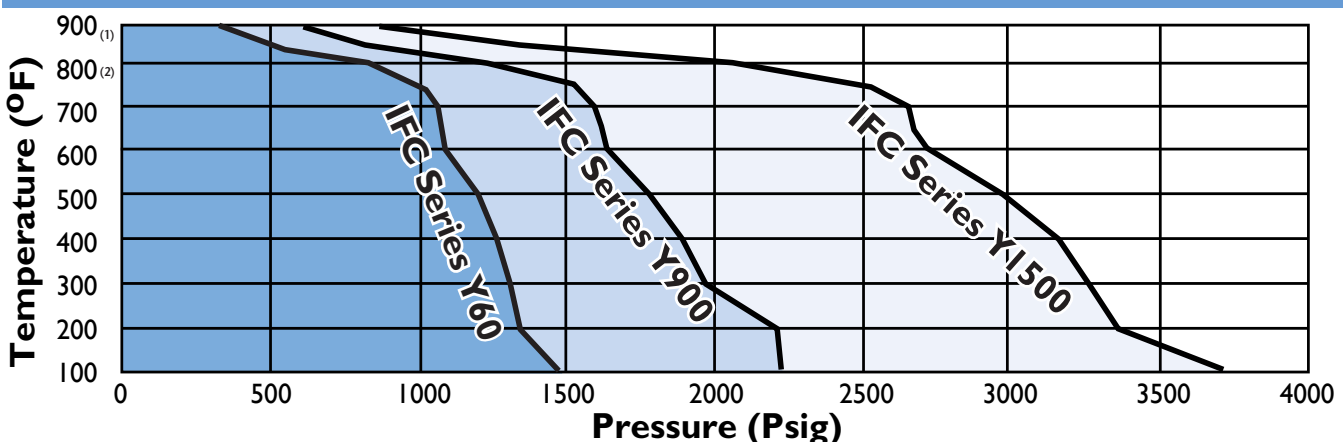

- Notes:** 1. Graphite filled 304 SS Spiral Wound gaskets limited to 900°F in an oxidizing atmosphere.
When operating strainers at higher temperatures please consult factory.
2. Upon prolonged exposure to temperatures above 800°F, the carbide phase of carbon steel may be converted to graphite.

Standard Screens

Size range	Opening
2" - 3"	0.045 in.
50mm - 80mm	1.2mm
4" & larger	0.125 in.
100mm & larger	3.2mm

Note: Flanged end strainer shown.
Butt-weld end strainer dimensionally the same.

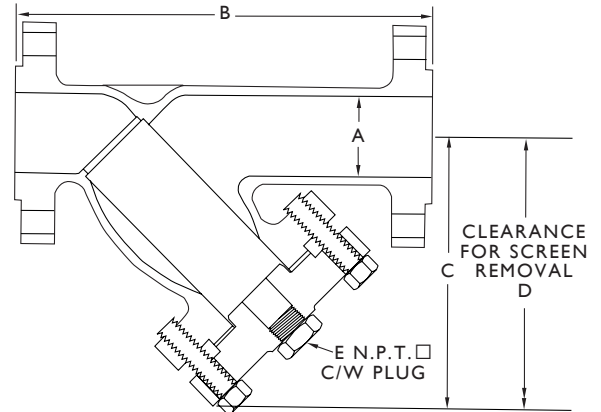

Dimensional Data (Class 600)

Size ¹ in (mm)	A in (mm)	B ² in (mm)	C in (mm)	D in (mm)	E NPT ³ in (mm)	Weight Lb. (Kg.)
2" 50	2.00 51	12.50 318	8.00 203	9.00 229	1/2 15	45 20
3" 80	3.00 76	15.63 397	10.13 257	11.38 289	1 1/4 32	109 49
4" 100	4.00 102	20.00 508	13.00 330	14.50 368	1 1/2 40	197 89
6" 150	6.00 152	25.50 648	17.00 432	19.25 489	2 50	409 186
8" 200	7.88 200	30.00 330	21.38 543	23.00 584	2 50	710 322
10" 250	9.75 248	37.50 953	24.75 629	27.75 705	2 50	1430 549
12" 300	11.75 298	45.50 1156	36.00 914	41.00 1041	2 50	1750 794

Dimensional Data (Classes 900, 1500) *use columns from chart above

	900Y	1500Y	900Y	1500Y	900Y	1500Y	900Y	1500Y	900Y	1500Y	900Y	1500Y
2" 50	1.87 48	1.87 48	16.25 413	16.25 413	10.50 268	10.50 268	14.88 378	14.88 378	OPT.	OPT.	125 57	125 57
2 1/2" 65	2.25 57	2.25 57	19.38 492	19.38 492	13.19 335	13.19 335	18.63 473	18.63 473	OPT.	OPT.	145 66	145 66
3" 80	2.87 73	2.75 73	20.25 514	22.25 565	12.75 324	14.50 368	18.00 457	20.50 521	OPT.	OPT.	163 74	234 106
4" 100	3.87 98	3.63 92	23.25 541	25.25 641	15.00 381	16.38 416	21.25 539	23.00 584	OPT.	OPT.	253 115	355 161
6" 150	5.75 146	5.38 137	27.75 705	32.00 813	18.88 480	21.69 551	26.65 677	30.50 775	OPT.	OPT.	550 250	812 368
8" 200	7.50 191	7.00 178	34.50 876	41.00 1041	22.63 575	27.00 686	32.00 813	39.00 991	OPT.	OPT.	1075 488	1725 782

Notes:

- Other sizes available.
- Consult factory for strainers with butt-weld ends.

3a. Other sizes and connection types available. Consult factory.

3b. IFC Series Y900 and Y1500 strainers are not furnished with a drain/blow-down connection.
If required consult factory.

The following optional features are available on all or most of IFC Y-Strainers. Please consult factory if required feature not shown.

Features & Availability	
Feature	Description of Availability
Screen openings	Range 5 micron to 1/2" perf.
Screen materials	Carbon steel, stainless steel (304/316 and L grades), alloy 20, monel 400, hastalloy C, Titanium, etc.
Screen construction	Perforated plate, mesh and wedge wire.
Gaskets	Any material commercially available.
Special body materials	Consult factory.
Special external coatings	All types of applied or baked on coatings available.
Special Internal coatings / linings	All types of applied or baked on coatings/linings available. ¹
Oxygen service	Specially cleaned and packed - performed on request.
Silicon free contamination	Specially cleaned and packed - performed on request.
Sour Service	Qualified per NACE MR0175 (rev. 1994).
Canadian Registration (CRN)	Available on most models in province of installation.
Special NDE	See documented testing below.

Note: 1. Strainer size may effect the ability to apply certain coatings and linings.

Documented Testing

All equipment manufactured by IFC is tested to customer and code requirements. Only superior quality castings from approved foundries are used in the production of IFC cast Y-Strainers. Full material traceability is available for all our strainers.

Please contact our QA/QC department for additional information and clarification.

Description of Test/Process	Applicable Standards	Extent of Test
Hydrostatic and pneumatic	ASME code employed in shell design (i.e. ASME B16.5)	100%
	Per UG-99, UG-100, UG-101 of ASME Section VIII, Div. I MSS-SP61 and customers specs	Upon customers request Upon customers request
Visual and Dimensional	Applicable ASME Standards	100%
Hardness	NACE MR01-75	Upon customers request
X-Ray	ASME Section VIII, Div. I ASME B16.34 - Annex B	Upon customers request
Dye Penetrant	ASME B16.34 - Annex D	100% Upon customers request
Magnetic Particle	ASME B16.34 - Annex C	100% Upon customers request
Ultrasonic	ASME Section VIII, Div. I	Upon customers request

Factors To Consider

Purpose

If the basket strainer is being used for protection rather than direct filtration, IFC's standard screens will suffice in most applications.







Service

With services that require extremely sturdy screens, such as high pressure/ temperature applications or services with high viscosities, IFC recommends that perforated screens without mesh liners be used. If mesh is required to obtain a certain level of filtration, then IFC recommends a trapped perf./mesh/perf. combination.

Filtration Level

When choosing a perf. or a mesh/perf. combination attention should be given to ensure overstraining does not occur. As a general rule the specified level of filtration should be no smaller than half the size of the particle to be removed. If too fine a filtration is specified the pressure drop through the strainer will increase very rapidly, possibly causing damage to the basket.

Screen Types/Dimensions

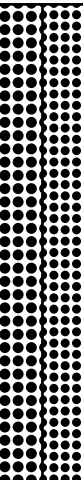
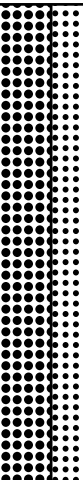
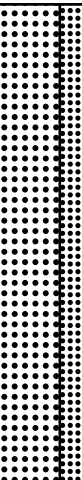
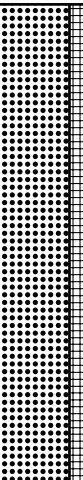
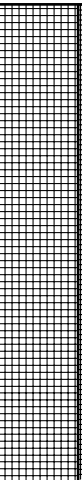
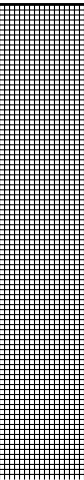
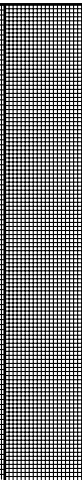
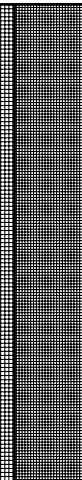
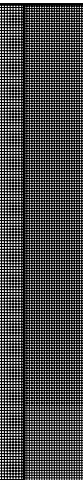
														
1/4" Dia. - 40% O.A.	3/16" Dia. - 50% O.A.	5/32" Dia. - 58% O.A.	1/8" Dia. - 40% O.A.	3/32" Dia. - 39% O.A.	1/16" Dia. - 37% O.A.	3/64" Dia. - 36% O.A.	1/32" Dia. - 40% O.A.	0.027" Dia. - 23% O.A.	20 Mesh - 49% O.A. 0.035" Openings	30 Mesh - 45% O.A. 0.022" Openings	40 Mesh - 41% O.A. 0.016" Openings	60 Mesh - 38% O.A. 0.010" Openings	80 Mesh - 36% O.A. 0.008" Openings	100 Mesh - 30% O.A. 0.006" Openings

- Notes:**
1. Screen openings other than those shown above are readily available.
IFC inventories various mesh sizes as fine as 5 micron and perforated plate as coarse as 1/2" Dia.
 2. Screens are available in a wide range of materials.
IFC inventories various screen material in carbon steel, stainless steel (304, 316), alloy 20, monel 400, hastalloy C and titanium grade 2.
 3. Custom manufactured screens are available upon request. Please consult factory.

Y-Strainer Pressure Drop — Liquids (Sizes 1/4 - 1 1/2)

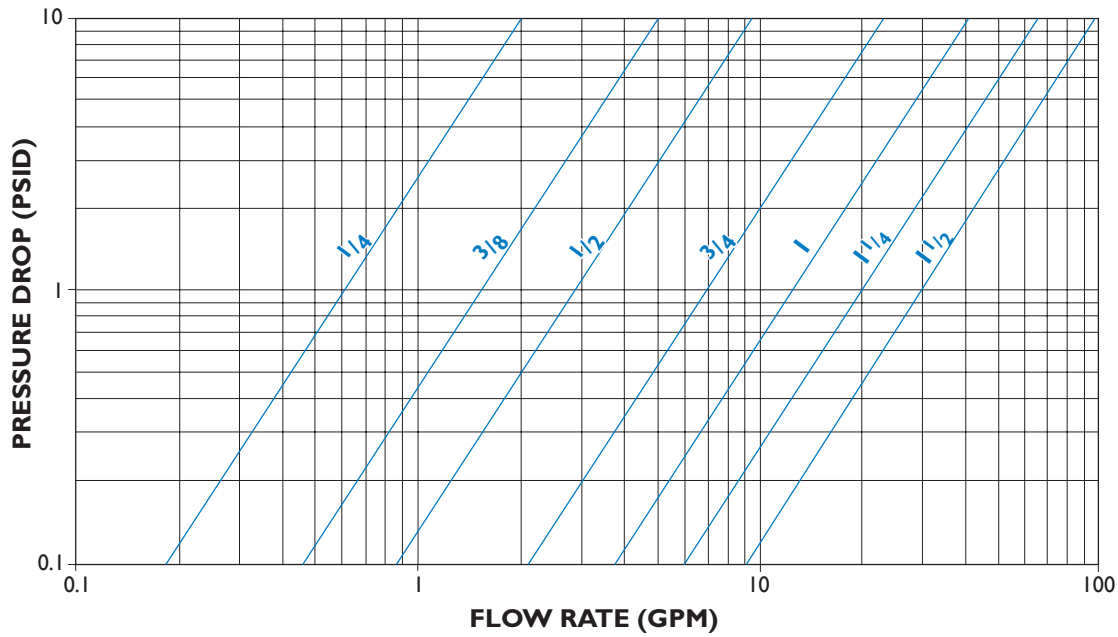

FIGURE 1

Y-Strainer Pressure Drop — Liquids (Sizes 2 - 16)

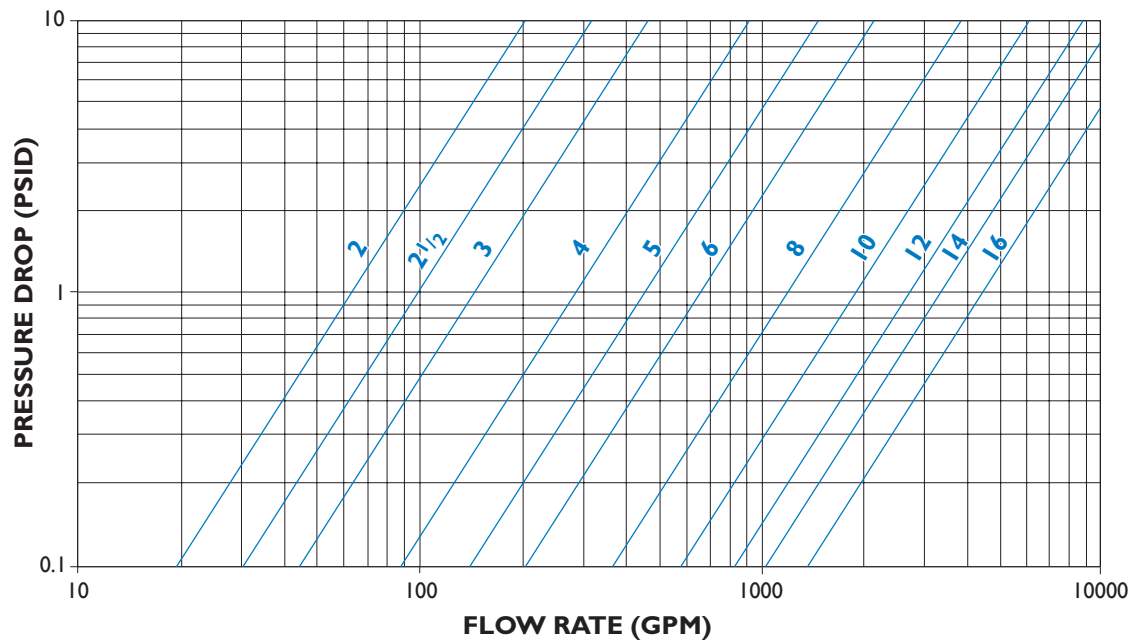

FIGURE 2

Notes: 1. Pressure drop curves are based on water flow with standard screens.
See page 22 for correction factors to be used with other fluids and/or screen openings.

For Non-Standard and Mesh Lined Screens

*Multiply values obtained from figure 1 thru 4 by the appropriate values shown below

Chart #1

Size Range	SCREEN OPENINGS							
	Perforated Plate % Screen Material Open Area					Mesh lined standard screens % Screen Material Open Area		
	60%	50%	40%	30%	20%	50%	40%	30%
1/4" - 1 1/2"	0.45	0.55	0.7	1	1.15	1.05	1.05	1.2
2" - 16"	0.65	0.8	1	1.4	2.15	1.05	1.05	1.2

Notes: 1. See page 20 for % Open Area's of IFC inventoried perforated plate.

2. Standard screens for sizes 1/4" to 1 1/2" is approximately a 30% open area screen media.

3. Standard screens for sizes 2" and larger is approximately a 40% open area screen media.

Example:

Strainer Size:	1 1/4"	A) Using figure 1 the pressure drop is determined to be 1.0 psid with IFC's standard screen.
Filtration:	100 Mesh lined 1/32" Perf.	B) Looking at page 20 we find that the % Open area of 100 mesh is 30%.
Flow rate:	30 GPM	C) Using chart 1 we read the correction factor to be 1.2 for 100 mesh lined 1/32" perf.
Service:	Water	D) Total pressure drop equals 1.0 x 1.2 = 1.2 psid clean.

Viscosity and Density Correction Factor Chart

* For use see instructions below.

Size Range	Chart #2		Chart #3				
	Component Factor (CF)	Viscosity Cp	Body Loss Factor (BF)	Screen Loss Factor			
				Perf alone (PF)	20 Mesh Lined (MF)	30, 40, Mesh Lined (MF)	60 to 300 Mesh Lined (MF)
1/4" - 1 1/2"	0.25	10	1	1.15	1.3	1.4	1.5
2" - 16"	0.35	25	1.2	1.25	2	2.2	2.5
		100	1.6	1.4	3	4	6.5
		200	2.2	1.5	4.5	7	11.5
		500	4.4	1.6	10	15	25
		1000	8	1.7	15	30	50
		2000	15.2	1.9	30	60	100

How to Use:

- 1) Using figures 1 or 2 determine the pressure drop (P1) through the strainer with water flow and standard screens.
- 2) If non-standard screens (i.e. 40 mesh, etc.) are being used apply factors in Chart #1 to determine corrected pressure drop (P2).
- 3) Multiply P1 or P2 (is used) by the specific gravity of the fluid actually flowing through the strainer to get P3.
- 4) Using Chart #2 multiply P3 by the appropriate Component Factor (CF) to get P4.
- 5) Let P5 = P3 - P4.
- 6) Multiply P4 by the appropriate Body Loss Factor (BF) in Chart #3 to get P6.
- 7) Multiply P5 by the appropriate Screen Loss factor (PF or MF) in Chart #3 to get P7.
- 8) Total pressure drop P8 = P6 + P7.

Example:

Strainer Size:	1 1/4"	A) As shown in the above example, the corrected pressure drop (P2) = 1.2 psid
Filtration:	100 Mesh lined 1/32" Perf.	B) Since S.G. = 1, P3 = P2 = 1.2 psid
Flow rate:	30 GPM	C) Using Chart #2 P4 = 0.25 x P3 = 0.30 psid
Specific Gravity:	1	D) P5 = 1.2 - 0.3 = 0.90 psid
Viscosity:	25 cP	E) Using Chart #3 P6 = 0.3 x 1.2 = 0.36 psid
		F) Again using Chart #3 P7 = 0.9 x 2.5 = 2.25 psid
		G) Total pressure drop P8 = 0.36 + 2.25 = 2.61 psid

Y-Strainer Pressure Drop — Saturated Steam (Sizes 1/4 - 1 1/2)

FIGURE 3

INLET PRESSURE (PSIG)

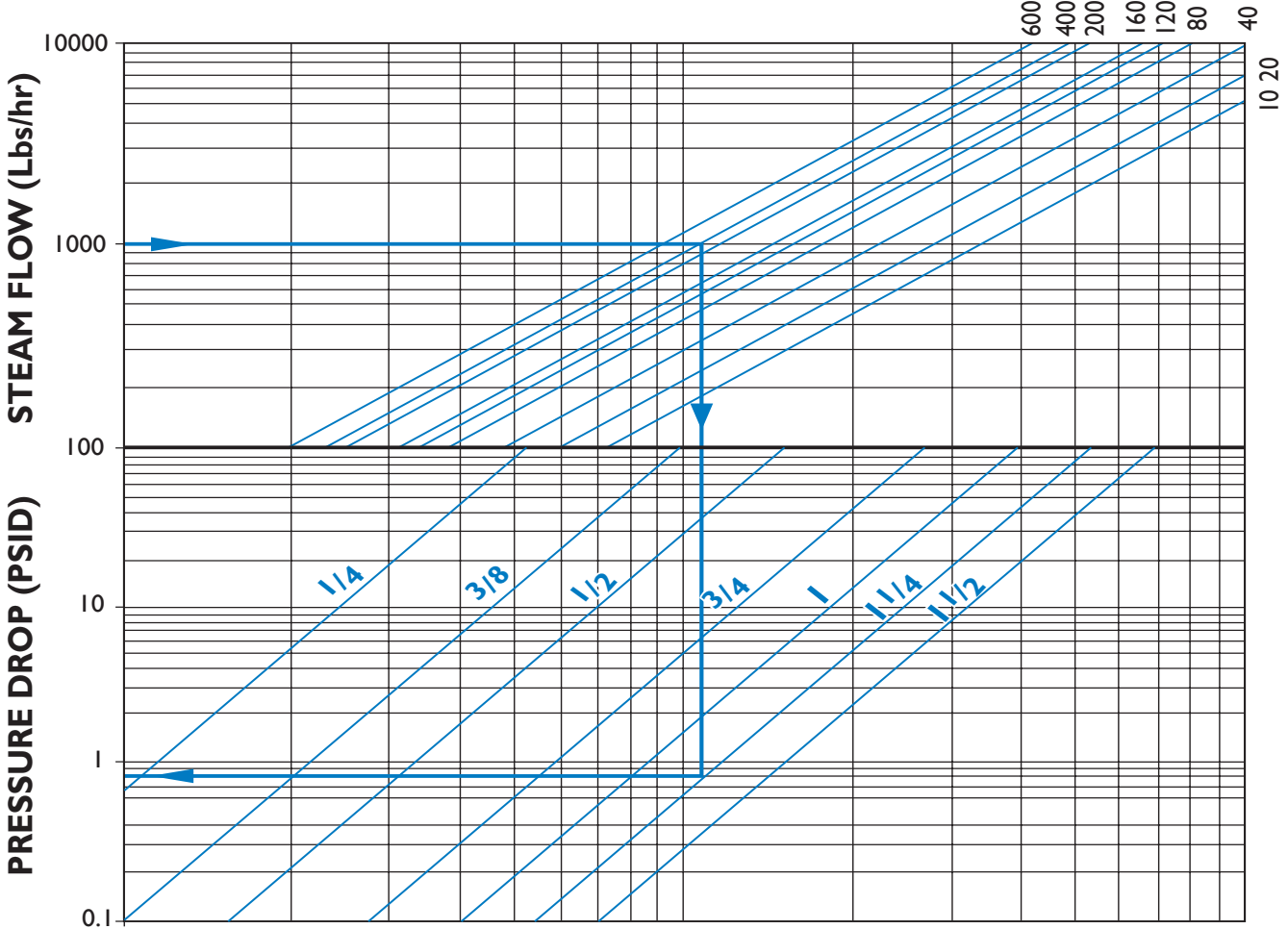

- Notes:**
1. Pressure drop curve is based on saturated steam flow with standard screens. See page 20 for correction factors to be used with other fluids and/or screen openings.
 2. Chart can be used for air and gas by using the following formula:

$$Q_s = 0.138 Q_g \sqrt{\frac{DP \le 1.0}{P_2}} \text{ s.g.}$$

FOR NON-CRITICAL FLOW

where;

- Q_s = Equivalent Steam Flow, lbs./hr.
- Q_g = Air or gas flow, SCFM.
- t = Temperature, °F.
- s.g. = Specific gravity (s.g. = 1 for air.)
- DP = Pressure Drop, psid
- P2 = Outlet Pressure

Example:

Service: Saturated Steam Flow
Pressure: 400 psig
Steam Flow: 1000 Lbs/hr
Size: 1 1/4"

- Locate steam flow
- Follow horizontal line to required pressure.
- Follow vertical line downwards to required strainer size.
- Follow horizontal line to read pressure drop.
- Pressure drop equals 0.8 psid.

Y-Strainer Pressure Drop — Saturated Steam (Sizes 2 - 16)

FIGURE 4

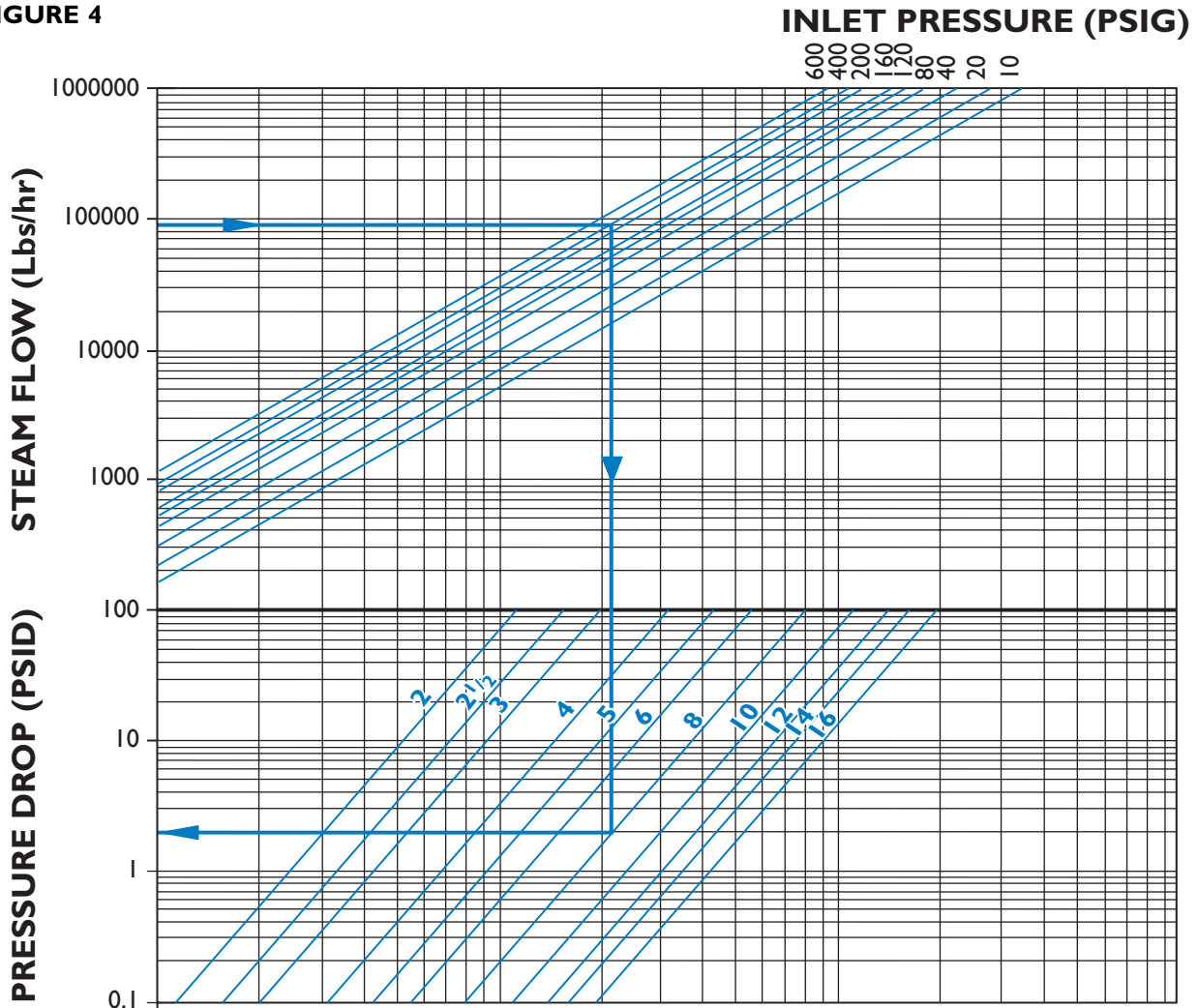

- Notes:** 1. Pressure drop curve is based on saturated steam flow with standard screens. See page 22 for correction factors to be used with other screen openings.
 2. Chart can be used for air and gas by using the following formula:

$$Q_s = 0.138 Q_g \sqrt{(460+t) \text{ s.g.}}$$

$$\left\{ \frac{DP}{P_2} \leq 1.0 \right\}$$

FOR NON-CRITICAL FLOW

where;

- Q_s = Equivalent Steam Flow, lbs./hr.
- Q_g = Air or gas flow, SCFM.
- t = Temperature, °F.
- s.g. = Specific gravity (s.g. = 1 for air.)
- DP = Pressure Drop, psid
- P_2 = Outlet Pressure

Example:

Service: Saturated Steam Flow
Pressure: 400 psig
Steam Flow: 90,000 Lbs/hr
Size: 8"

- Locate steam flow
- Follow horizontal line to required pressure.
- Follow vertical line downwards to required strainer size.
- Follow horizontal line to read pressure drop.
- Pressure drop equals 2.0 psid.

Correction Factors For Clogged Screens

* Multiply values obtained from figures 1 thru 4 and Charts #1, #2 and #3 (if used) by the appropriate values shown below

% Clogged	Ratio of Free Screen Area to Pipe Area							Chart #4
	10:1	8:1	6:1	4:1	3:1	2:1	1:1	
10%	-	-	-	-	-	-	3.15	
20%	-	-	-	-	-	1.15	3.9	
30%	-	-	-	-	-	1.4	5	
40%	-	-	-	-	-	1.8	6.65	
50%	-	-	-	-	1.25	2.5	9.45	
60%	-	-	-	1.15	1.8	3.7	14.5	
70%	-	-	-	1.75	2.95	6.4	26	
80%	-	1.1	1.75	3.6	6.25	14	58	
90%	2.3	3.45	6	13.5	24	55	-	

Notes: 1. See page 27 for the Ratio of Free Area to Pipe Area for IFC Y-Strainers equipped with standard screens.
 2. For screens other than IFC's standard use the following formula to calculate the Ratio Free Area to Pipe Area.

$$R = \frac{A_g \times OA}{100A_p}$$

where;

- R = Ratio Free Area to Pipe Area
- A_g = Gross screen area, sq. in. (See page 27)
- OA = Open area of screen media, % (See page 20, i.e. 1/8" perf. = 40%)
- A_p = Nominal area of pipe fitting, sq. in. (See page 27)

Example #1:

Strainer Size: 4"
IFC Series: Y150F
Filtration: 1/8" Perf.
Flow rate: 300 GPM
Service: Water
% Clogged: 60%

- A)** Using Figure #1 the pressure drop is determined to be 1.1 psid with IFC's standard screen.
- B)** Looking at page 27 the Ratio of Free Area to Pipe Area for a 4" IFC series Y150F strainer is equal to 2.72:1 (3:1 approx.).
- C)** Using Chart #4 we read the correction factor to be 1.80 at 60% clogged.
- D)** Total pressure drop equals 1.1 x 1.8 = 1.98 psid when 60% clogged.

Example #2:

Strainer Size: 12"
IFC Series: Y300F
Filtration: 3/16" Perf.
Flow rate: 2000 GPM
Service: Water
% Clogged: 70%

- A)** Using Figure #1 the pressure drop is determined to be 0.54 psid with IFC's standard screen.
- B)** Looking at page 20 we find that the % Open area (OA) of 3/16" Perf. is 50%.
- C)** Using Chart #1 we read the correction factor to be 0.8 for 3/16" Perf.
- D)** Total clean pressure drop equals 0.54 x 0.8 = 0.43 psid.
- E)** Since a non-standard screen is being used we must calculate the Ratio Free Area to Pipe Area using the above formula.
- F)** Looking at page 27 we find AG = 753.12 in², Ap = 113.10 in².
- G)** The Ratio Free Area to Pipe Area is calculated as 3.33:1. (3:1 approx.)
- H)** Using Chart #4 we read the correction factor to be 2.95 at 70% clogged.
- I)** Total pressure drop equals 0.43 x 2.95 = 1.27 psid when 70% clogged.

Y-Strainer Screen Burst Pressure

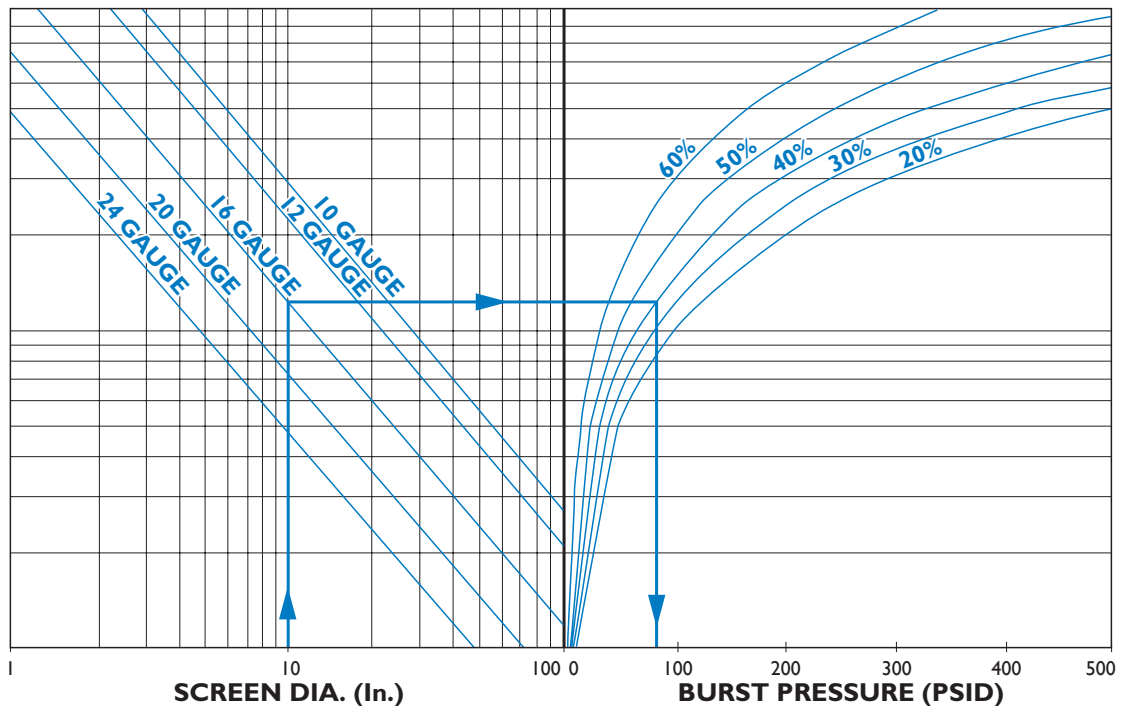

FIGURE 5

Note: 1. The above chart is for use with perforated plate and based on the formula:

$$P = \frac{St^2}{R - 0.4t}$$

P = Burst pressure, psid
 S = Reduced allowable stress, psi
 t = Thickness of perforated plate, in.
 R = Outside radius of screen, in.

SOURCE: ASME Section VIII, Div. I, Appendix I.

2. The above chart is based on a screen material of stainless steel and is valid for operating temperatures up to 100°F. The chart may be used for higher temperatures however it will result in a safety factor reduction. (At 100°F the chart's safety factor is approximately two (2), at 1000°F the chart safety factor is reduced to approximately one (1). It is the responsibility of the user to determine an acceptable safety factor.)
3. The chart may be used for carbon steel at an approximate 25% reduction in safety factor.
4. See page 20 for % Open Area's of IFC's inventoried perforated plate.

Example:

Strainer Size: 10"
Screen Thickness: 16 Gauge
Screen Perforations: 0.125" (40% O.A.)

- Locate screen diameter (assume a 10" diameter screen)
- Follow vertical line to gauge thickness.
- Follow horizontal line to required perforation open area.
- Follow vertical line downwards to read burst pressure.
- Burst pressure equals 80 psid approx.

IFC Series Y-Strainers - Effective Screen Areas

IFC Series	Pipe Size (In.)	Std. Opening (in.)	Nominal Area of Pipe Fitting (Sq. In.)	Gross Screen Area (Sq. In.)	Free Area (Sq. In.)	Ratio Free Area to Pipe Area	IFC Series	Pipe Size (In.)	Std. Opening (in.)	Nominal Area of Pipe Fitting (Sq. In.)	Gross Screen Area (Sq. In.)	Free Area (Sq. In.)	Ratio Free Area to Pipe Area
Y250TIT	1/4	0.032	0.05	3.64	1.02	20.79	Y250F	2	0.045	3.14	35.64	12.83	4.08
Y250TIT	3/8	0.032	0.11	3.64	1.02	9.24	Y250F	2 1/2	0.045	4.91	44.33	15.96	3.25
Y250TIT	1/2	0.032	0.20	4.05	1.13	5.78	Y250F	3	0.045	7.07	56.45	20.32	2.88
Y250TIT	3/4	0.032	0.44	6.63	1.86	4.20	Y250F	4	0.125	12.57	98.91	39.56	3.15
Y250TIT	1	0.032	0.79	9.06	2.54	3.23	Y250F	5	0.125	19.63	147.11	58.85	3.00
Y250TIT	1 1/4	0.032	1.23	12.14	3.40	2.77	Y250F	6	0.125	28.27	197.92	79.17	2.80
Y250TIT	1 1/2	0.032	1.77	17.87	5.00	2.83	Y250F	8	0.125	50.27	420.97	168.39	3.35
Y250TIT	2	0.032	3.14	30.07	8.42	2.68	Y250F	10	0.125	78.54	645.99	258.40	3.29
Y250TIT	2 1/2	0.045	4.91	45.16	16.26	3.31	Y250F	12	0.125	113.10	876.70	350.68	3.10
Y250TIT	3	0.045	7.07	60.30	21.71	3.07	Y250F	14	0.125	137.89	1186.34	474.54	3.44
Y125TBT	1/4	0.032	0.05	4.71	1.32	26.38	Y150F	1/2	0.032	0.20	5.91	1.65	8.43
Y125TBT	3/8	0.032	0.11	4.71	1.32	11.99	Y150F	3/4	0.032	0.44	8.97	2.51	5.69
Y125TBT	1/2	0.032	0.20	4.71	1.32	6.59	Y150F	1	0.032	0.79	12.71	3.56	4.53
Y125TBT	3/4	0.032	0.44	7.22	2.02	4.59	Y150F	1 1/2	0.032	1.77	23.01	6.44	3.65
Y125TBT	1	0.032	0.79	9.33	2.61	3.31	Y150F	2	0.045	3.14	28.27	10.18	3.24
Y125TBT	1 1/4	0.032	1.23	13.53	3.79	3.08	Y150F	2 1/2	0.045	4.91	50.76	18.27	3.72
Y125TBT	1 1/2	0.032	1.77	19.25	5.39	3.05	Y150F	3	0.125	7.07	62.59	25.03	3.54
Y125TBT	2	0.032	3.14	33.34	9.34	2.25	Y150F	4	0.125	12.57	85.34	34.14	2.72
Y125TBT	2 1/2	0.045	4.91	35.52	12.79	2.60	Y150F	6	0.125	28.27	210.88	84.35	2.98
Y125TBT	3	0.045	7.07	48.55	17.48	2.47	Y150F	8	0.125	50.27	323.98	129.59	2.58
							Y150F	10	0.125	78.54	513.21	205.28	2.61
							Y150F	12	0.125	113.10	690.41	276.17	2.44
Y250TBT	1/2	0.032	0.20	2.80	0.78	3.99	Y300F	1/2	0.032	0.20	6.75	1.89	9.45
Y250TBT	3/4	0.032	0.44	7.81	2.19	4.95	Y300F	3/4	0.032	0.44	10.30	2.88	6.55
Y250TBT	1	0.032	0.79	8.76	2.45	3.12	Y300F	1	0.032	0.79	14.99	4.20	5.32
Y250TBT	1 1/4	0.032	1.23	14.91	4.18	3.40	Y300F	1 1/2	0.032	1.77	30.42	8.52	4.81
Y250TBT	1 1/2	0.032	1.77	20.98	5.88	3.32	Y300F	2	0.045	3.14	29.85	10.74	3.42
Y250TBT	2	0.032	3.14	30.96	8.67	2.76	Y300F	2 1/2	0.045	4.91	48.81	17.57	3.58
							Y300F	3	0.125	7.07	68.22	27.29	3.86
Y150/Y300	1/2	0.032	0.20	3.11	0.87	4.44	Y300F	4	0.125	12.57	102.90	41.16	3.28
Y150/Y300	3/4	0.032	0.44	5.17	1.45	3.28	Y300F	6	0.125	28.27	230.83	92.33	3.27
Y150/Y300	1	0.032	0.79	7.85	2.20	2.80	Y300F	8	0.125	50.27	336.64	134.66	2.68
Y150/Y300	1 1/4	0.032	1.23	10.01	2.80	2.29	Y300F	10	0.125	78.54	559.50	223.80	2.85
Y150/Y300	1 1/2	0.032	1.77	14.28	4.00	2.26	Y300F	12	0.125	113.10	753.12	301.25	2.66
Y150/Y300	2	0.032	3.14	21.35	5.98	1.90							
Y600	1/2	0.032	0.20	2.82	0.79	4.03	Y600F	2	0.045	3.14	39.17	14.10	4.49
Y600	3/4	0.032	0.44	4.15	1.16	2.63	Y600F	2 1/2	0.045	4.91	56.45	20.32	4.14
Y600	1	0.032	0.79	8.14	2.28	2.90	Y600F	3	0.125	7.07	74.96	29.98	4.24
Y600	1 1/4	0.032	1.23	11.85	3.32	2.70	Y600F	4	0.125	12.57	128.41	51.37	4.09
Y600	1 1/2	0.032	1.77	16.59	4.65	2.63	Y600F	6	0.125	28.27	255.94	102.38	3.62
Y600	2	0.045	3.14	27.10	9.75	3.11	Y600F	8	0.125	48.77	403.57	161.43	3.31
							Y600F	10	0.125	74.66	602.08	240.83	3.23
							Y600F	12	0.125	108.43	820.18	328.07	3.03
Y1500	1/2	0.032	0.20	5.08	1.42	7.25	Y900F	2	0.045	2.78	49.06	17.66	6.36
Y1500	3/4	0.032	0.44	7.11	1.99	4.51	Y900F	3	0.125	6.51	107.45	42.98	6.60
Y1500	1	0.032	0.79	11.90	3.33	4.24	Y900F	4	0.125	11.82	152.93	61.17	5.17
Y1500	1 1/4	0.032	1.23	23.32	6.53	5.32	Y900F	6	0.125	25.97	279.99	112.00	4.31
Y1500	1 1/2	0.032	1.77	23.28	6.52	3.69	Y900F	8	0.125	44.18	454.60	181.84	4.12
Y1500	2	0.045	3.14	29.85	10.75	3.42							
Y125F	2	0.045	3.14	30.07	10.82	3.45	Y1500F	2	0.045	2.78	49.06	17.66	6.36
Y125F	2 1/2	0.045	4.91	44.33	15.96	3.25	Y1500F	3	0.125	5.94	107.45	42.98	7.24
Y125F	3	0.045	7.07	56.45	20.32	2.88	Y1500F	4	0.125	10.29	155.17	62.07	6.03
Y125F	4	0.125	12.57	98.91	39.56	3.15	Y1500F	6	0.125	22.73	307.12	122.85	5.40
Y125F	5	0.125	19.63	147.11	58.85	3.00							
Y125F	6	0.125	28.27	179.19	71.68	2.54							
Y125F	8	0.125	50.27	334.38	133.75	2.66							
Y125F	10	0.125	78.54	505.21	202.08	2.57							
Y125F	12	0.125	113.10	665.77	266.31	2.35							
Y125F	14	0.125	137.89	1186.34	474.54	3.44							
Y125F	16	0.125	182.65	1446.85	578.74	3.17							

- Notes:**
1. Values shown are for strainers with standard screens.
 2. Ratio Free Area to Pipe Area may be increased by changing perf. stagger or by using mesh.
 3. In many cases the specified screen burst pressure limits the maximum value for the Ratio Free Area to Pipe Area.



Check List and Suggested Specifications For ISLIP Flow Controls Inc.

Strainer Check List: When selecting a strainer, please take the factors listed below into account. This will assist us when recommending a strainer to suit your specific requirements. Please photocopy this page and fill out the pertinent information.

1. Fluid to be strained _____
2. Flow rate _____
3. Density of fluid _____
4. Viscosity of fluid _____
5. Fluid working pressure _____
Maximum pressure _____
6. Fluid working temp. _____
Maximum temp. _____
7. Preferred material of strainer construction _____

8. Present pipeline size & material _____
9. Nature of solids to be strained out _____
10. Size of solids to be strained out _____
Size of mesh or perf. req. _____
11. Clearance Limitation Above _____ Below _____
Left side facing inlet _____ Right side facing inlet _____
12. Maximum pressure drop with clean screen _____
13. Expected cleaning frequency _____
14. Any other information deemed relevant _____

Suggested Specifications

The strainer shall be a Y-Type and have _____ (size) inlet/outlet connections. The end connections shall be (flanged, threaded etc.) and the body shall be complete with a _____ (bolted, quick-opening, etc.) cover assembly. The strainer shall be suitable for _____ PSIG operating pressure at _____ °F operating temperature. The body shall be constructed of _____ (body material) while the screen shall be constructed of _____ (basket or screen material). A mesh lining of _____ (size of mesh) is required, allowing a maximum pressure drop of _____ psig. The strainer shall be equipped with a _____ (gasket material) gasket and the strainer screen shall be able to withstand _____ psig differential pressure without any deformation. Strainers shall be IFC Model # _____ or approved equivalent.

Name _____
Company _____
Address _____
City/Town _____
State _____ Zip Code _____
Telephone (_____) _____
Fax (_____) _____

1.0 Strainer Installation Instructions

- A. Ensure all machined surfaces are free of defects and that the inside of the strainer is free of foreign objects.
- B. For horizontal pipelines, the strainer should be installed so that the drain connection is pointed downwards.
- C. For flanged end strainers, the flange bolting should be tightened gradually in a back and forth clockwise motion. Threaded end strainers should use an appropriate sealant.
- D. Once installed, increase line pressure gradually and check for leakage around joints.
- E. If the strainer is supplied with a start-up screen, monitor pressure drop carefully.

IMPORTANT! Ultimate responsibility for strainer and material selection rests with the customer, as only the customer knows the particular use to which the strainer will be put and the exact operating parameters to which it will be subjected.

2.0 Strainer Removal Instructions

- A. Drain piping.
- B. Vent line to relieve pressure.
- C. Loosen flange bolts (Flanged ends)
- D. Secure necessary lifting equipment to strainer assembly.
- E. Remove inlet/outlet flange bolts (flanged end), cut pipe (socket weld, butt weld and sweat end) or unthread (threaded ends) and carefully remove strainer.
- F. Tighten cover. The strainer is ready for line start-up.

CAUTION SHOULD BE TAKEN DUE TO POSSIBLE EMISSION OF PROCESS MATERIAL FROM PIPING. ALWAYS ENSURE NO LINE PRESSURE EXISTS WHEN OPENING COVER.

3.0 Maintenance Instructions

For maximum efficiency, determine the length of time it takes for the pressure drop to double that in the clean condition. Once the pressure drop reaches an unacceptable value, shut down line and follow the "Strainer Removal Instructions" above.

A pressure gauge installed before and after the strainer in-line will indicate pressure loss due to clogging and may be used to determine when cleaning is required.

4.0 Trouble Shooting Guides and Diagnostic Techniques

- A. After pressurizing, inspect cover and other joints for leakage. Gasket replacement or cover tightening is necessary if leakage occurs.
- B. If the required filtration is not taking place, ensure the screen is installed in the correct position, that being flush to the upper and lower screen seating surfaces.

5.0 Limited Warranty

All products are warranted to be free of defects in material and workmanship for a period of one year from the date of shipment, subject to the limitations below: If the purchaser believes a product defective, the purchaser shall:

- A. Notify the manufacturer, state the alleged defect and request permission to return the product.
- B. If permission is given, return the product with transportation prepaid. If the product is accepted for return and found to be defective, the manufacturer will, at its discretion, either repair or replace the product, f.o.b. factory, within 60 days of receipt, or refund the purchase price.

Other than to repair, replace or refund described above, the purchaser agrees that the manufacturer shall not be liable for any losses, costs, expenses or damages of any kind arising out of the product, its use, installation or replacement, labeling, instructions, information or technical data of any kind, description of product use, sample or model, warnings or lack of foregoing. No other warranties, written or oral, expressed or implied, including the warranties of fitness for a particular purpose and merchantability, are made or authorized. No affirmation of fact, promise, description of product use or sample or model shall create any warranty from the manufacturer, unless signed by the president. These products are not manufactured, sold or intended for personal, family or household purposes.

Size In.	6"
Strainer Type	Y = Y Strainer
Class	125 = 125 lb. 150 = 150 lb. 250 = 250 lb. 300 = 300 lb. 600 = 600 lb. 900 = 900 lb. 1500 = 1500 lb.
Type of Connection	T = NPT Threaded SW = Socket Weld S = Sweat End F = Flanged (RF or FF depending on standard of construction) BW = Buttweld RTJ = Ring Joint
Body Material	I = A126-B Cast Iron DI = A395 Ductile Iron B = B62 Bronze S = A216-WCB Carbon Steel LCB = A352-LCB Steel LCC = A352-LCC Steel 52CM = A217-WC6 Chrome Molly 94CM = A217-WC9 Chrome Molly SS = A351-CF8M Stainless Steel A20 = A351-CN7M Alloy 20
Cover Type	T = Threaded cover B = Bolted cover
Specials/Other	1 = Non-standard screen 2 = Non-standard gasket 3 = Special external coating 4 = Special internal coating 5 = Oxygen Service 6 = NACE MR01-75 Compliance 7 = Silicon Free 8 = Special N.D.E. 9 = Other Special
A	
B	
C	
D	
E	
F	
G	